

Reverse Rotation in Centrifugal Compressors

40th Turbomachinery Symposium
12-15 September 2011 – Houston, TX
Presented by Amr Gad

Outline

- Introduction
- Process overview
- Compressor design & construction
- Narrative of reverse rotation events
- Cause of reverse rotation
- Possible impacts of reverse rotation
- Mitigating actions taken
- Lessons learned
- Conclusion

Introduction

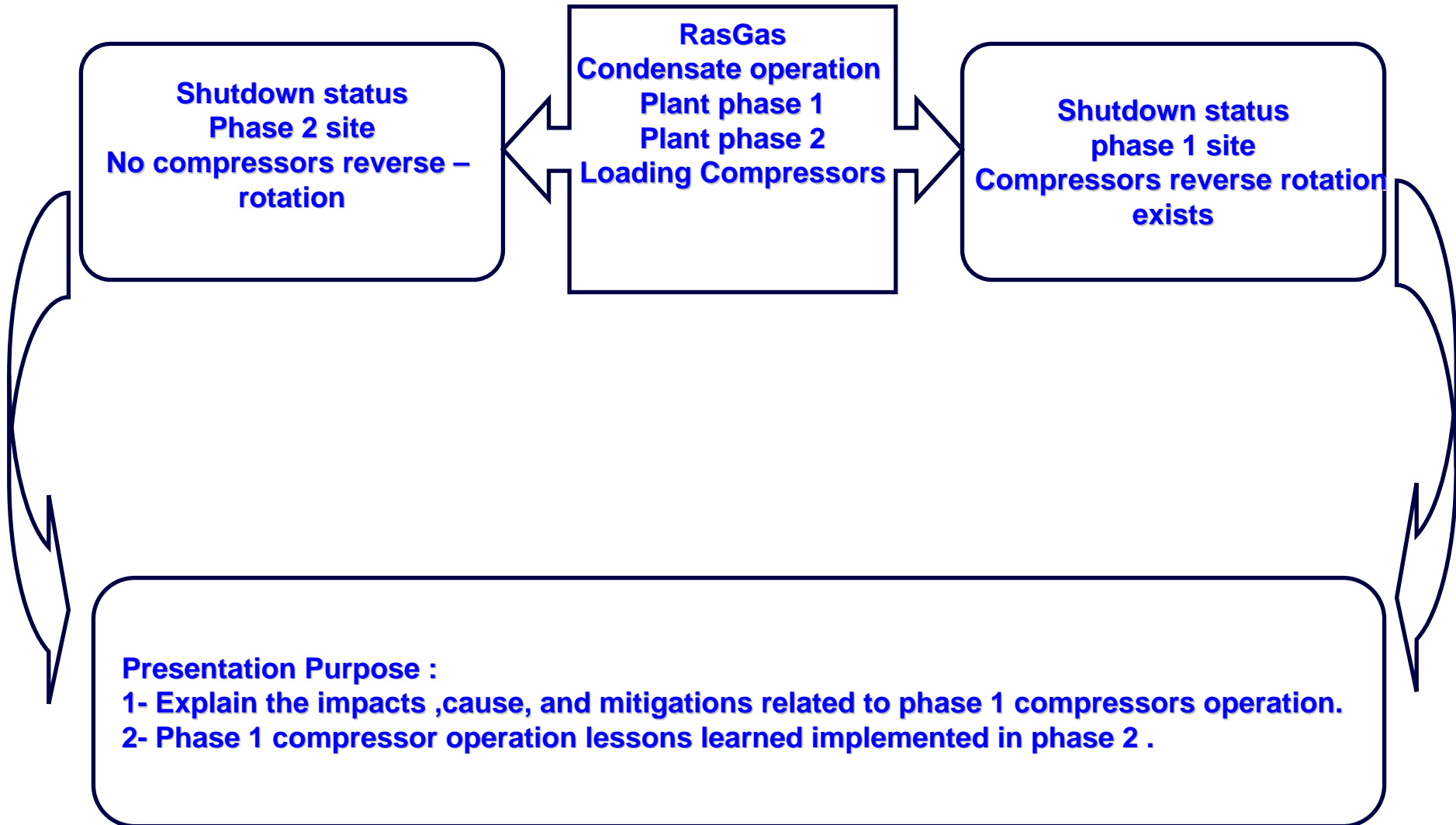

Process Overview

Phase 1 (since 2005)

- Six compressors.
- Design pressure ratio for LP ,MP, HP is about 3 for each stage (P_d / P_s).
- Design overall pressure ratio for the machine about 28 (P_d / P_s).
- Volume of suction vessels LP, MP, HP more than 50 meter cube for each.

Phase 2 (since 2009)

- Four compressors in operation.
- Similar design pressure ratio & overall pressure ratio as phase 1.
- Triple the volume of suction vessels compare to phase 1.

Process Overview

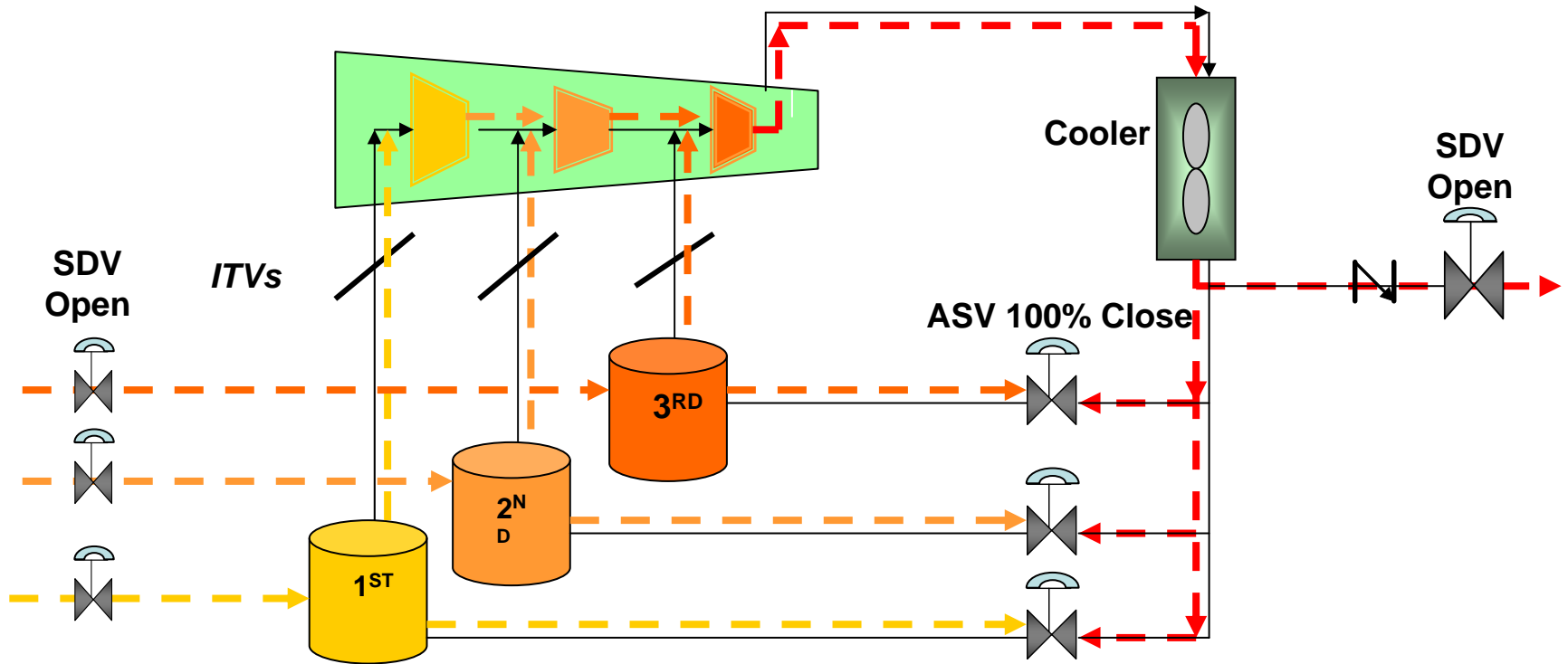

Machines During Normal Operation

Compressor Design & Construction

Phase 1

- Unit configuration: Fixed speed electric motor & gear box & compressor.
 - Compressor rated at: 3.7MW
 - Motor rated at: 4.2 MW
 - Gear box speed: 1480 / 10258 RPM
 - Compressor operating speed: 10258 RPM
- Seal configuration: Unidirectional dry gas seal.
- Bearing construction:
 - Compressor: Tilt pad self equalizing
 - Motor: Cylindrical sleeve bearing
- Gear box design: Double helical.
- Lube oil: Rundown tank with two AC pumps (Main & Auxiliary).

Reverse Rotation Events

- Reverse rotation happened since commissioning of the machines.
- However, they were only discovered after 18 month of units operations. Late discovery was due to:
 - No reverse rotation detection system installed.
 - No prior experience in-house with reverse rotation in this type of process configuration.

Cause of Reverse Rotation

RCFA findings:

- Reverse hydraulic flow due to large amount of entrapped hydrocarbon volume in the piping and suction vessels of the MP & HP sections.

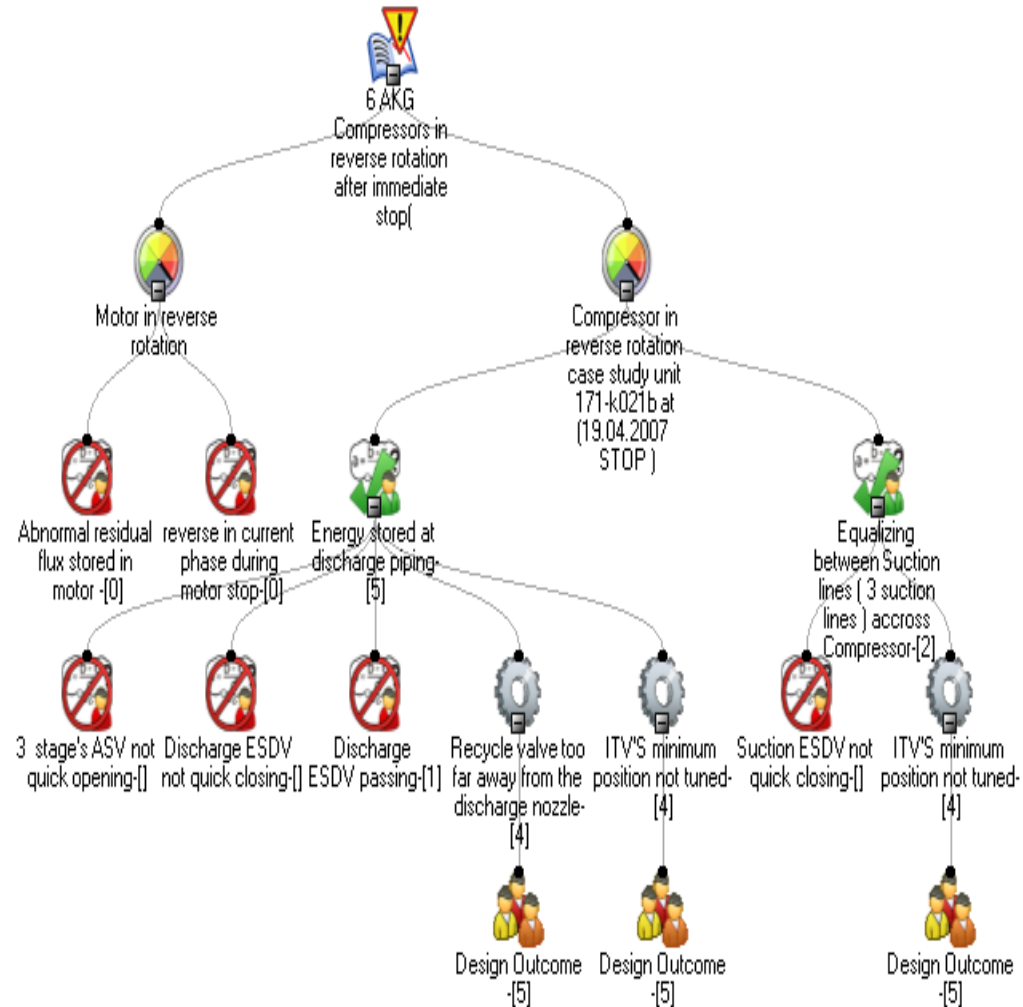

Cause of Reverse Rotation

- Hydraulic flow occurs after 10-15 seconds from a stop command till compressor coast down to zero RPM speed.
- Hydraulic flow during the reverse rotation from zero speed till 5000 RPM and back to zero again within 4 to 6 minutes.

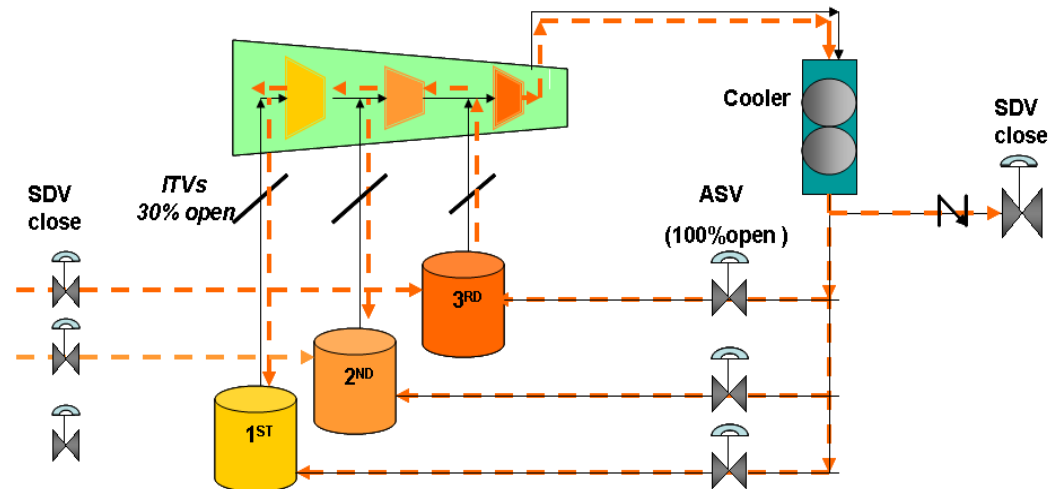
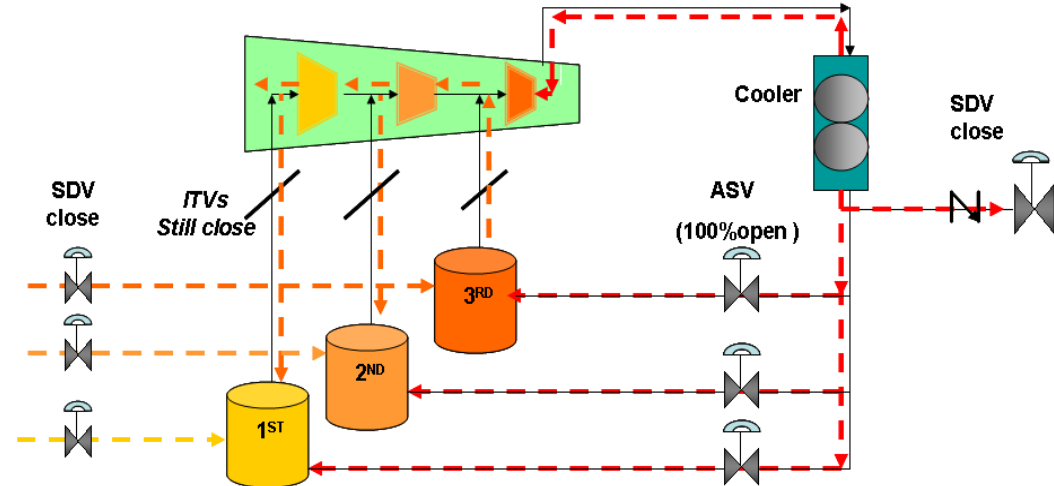

Cause of Reverse Rotation

Speed trend (Figure A)

- Unit stop very fast after stop command.
- Unit speed ramp up again in reverse rotation to almost 5000 RPM for the compressor.
- After speed reaches 5000 RPM it cost down again to zero speed in about 4-6 minutes.
- This phenomena is repeated each time the machine stops.

Flow rate trend (Figure B)

- Showing flow exchange & equalizing between stages.

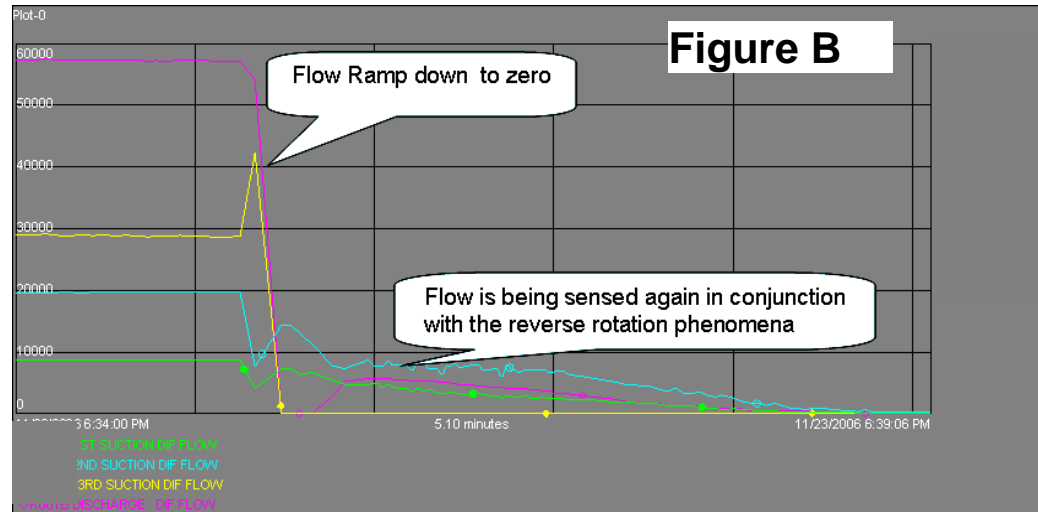
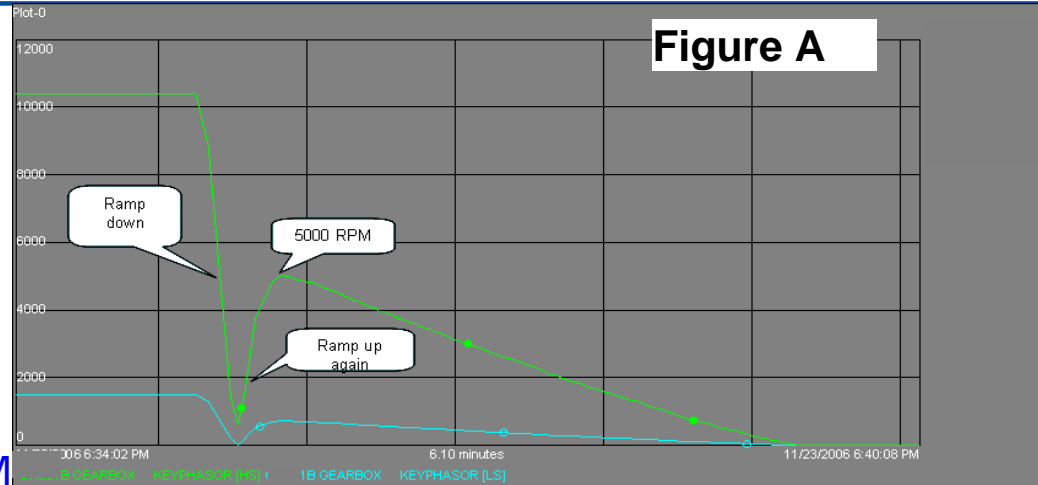

Possible Impacts of Reverse Rotation

Uncontrolled gas release from the compressors.

Existing unidirectional dry gas seal are not guaranteed for such modes of operations as per OEM guide lines.

Bearings damage

Lube oil system design doesn't support reverse rotation with total electric power black out , as auxiliary and emergency pumps is AC driven and the overhead tank is designed for only 3 minutes .

Compressor components failure due to reverse rotation

No detailed study conducted by OEM to confirm impacts on various machines components (Impeller vanes, diffusers, Labyrinth seals ,...etc).

Mitigating Actions. Phase 1 Compressors

- Minimize the number of units starts and stops until modify the system.
- Future installation of check valves at the suction of the LP & MP.

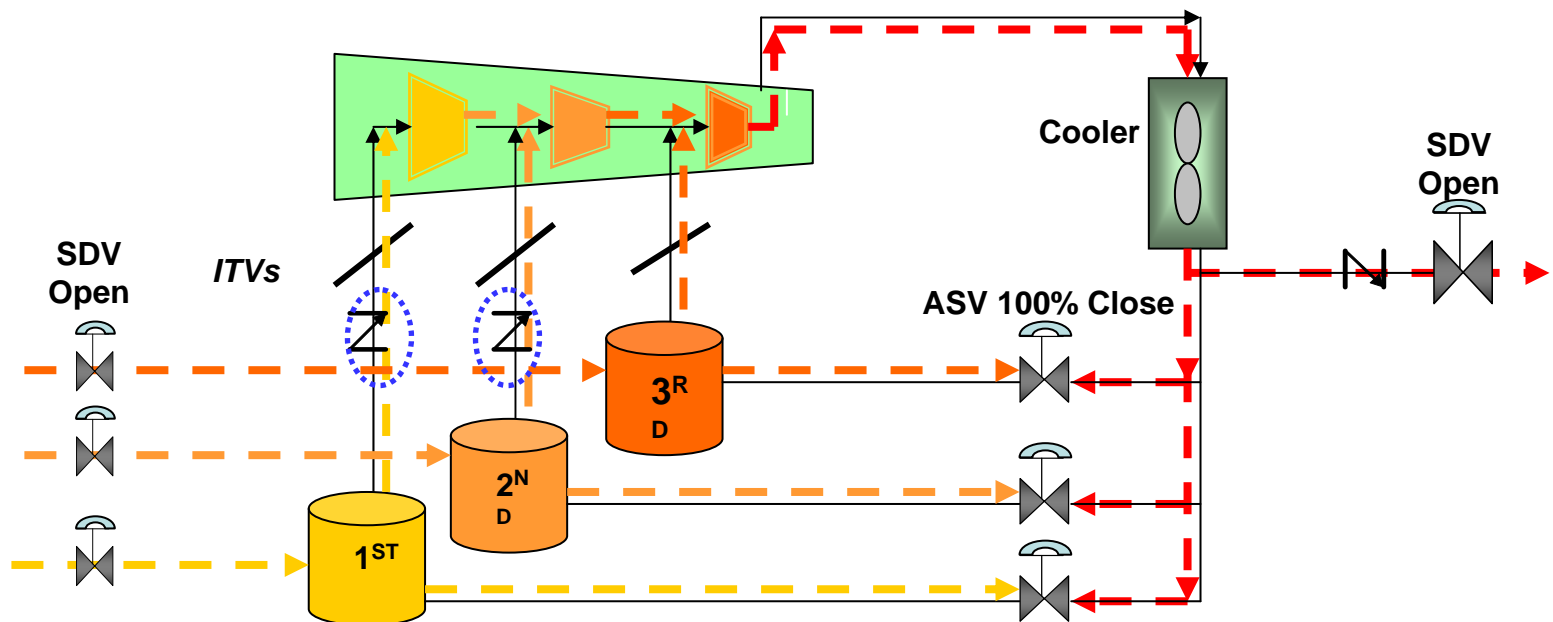

Mitigating Actions. Phase 2 Compressors

- Interim - modified the I&C for the ITV's of the MP & HP to fully close during machine stop.
- Final - install check valves at the suction of the LP, MP and immediately after the discharge.

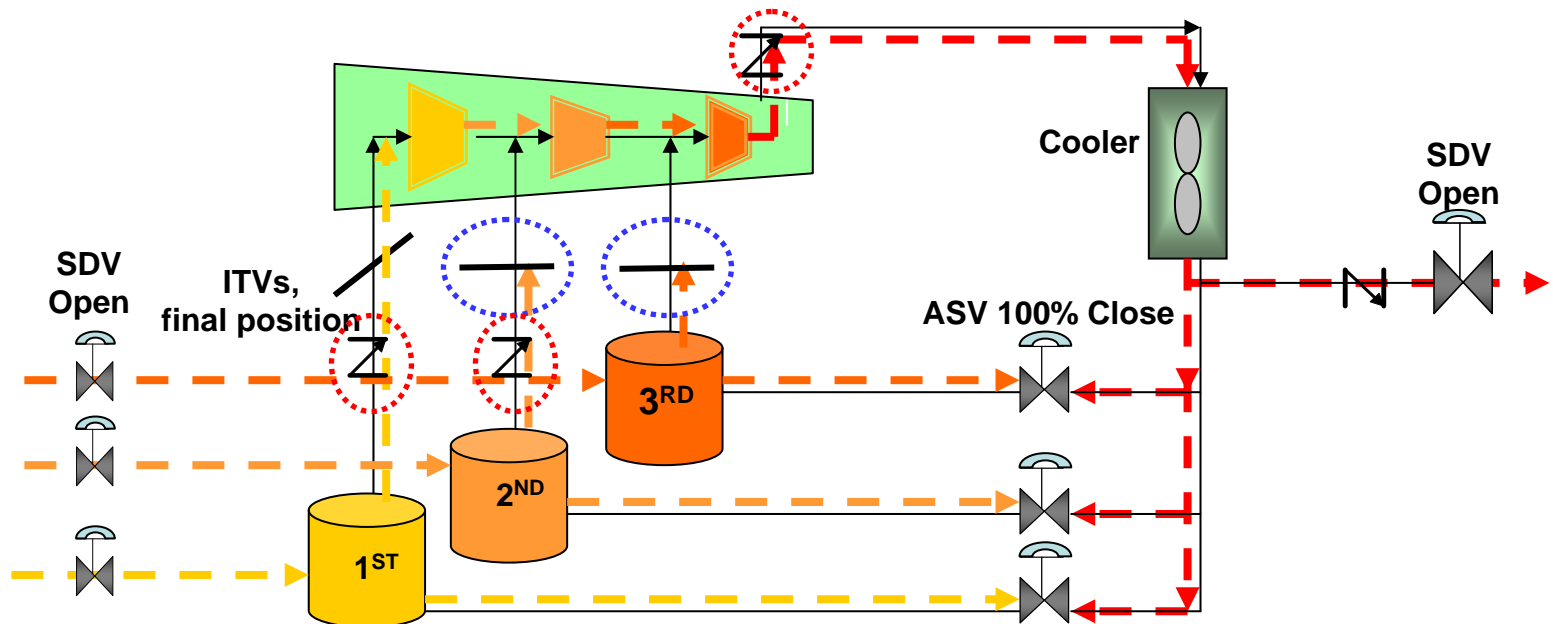

Mitigating Actions. Phase 2 Compressors

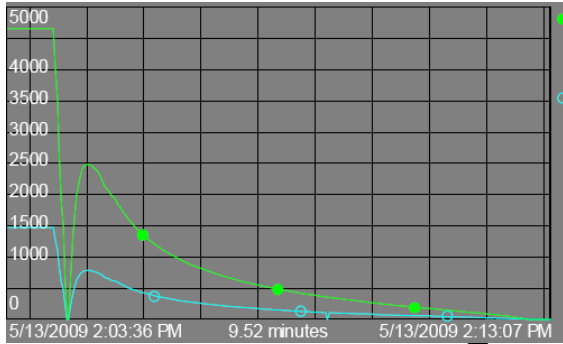

Shutdown with ITV closing before tuning

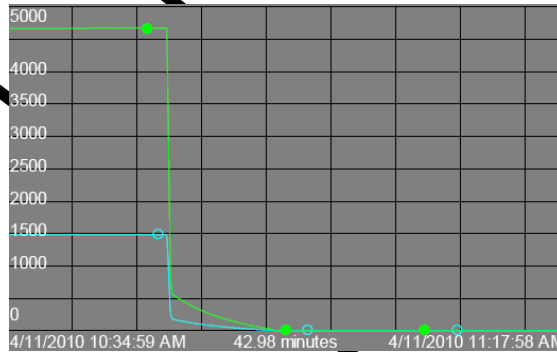

Shutdown With ITV closing after tuning

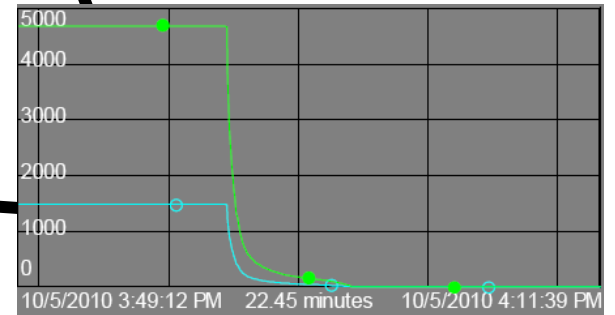

Shutdown with check valve installed and ITV closure removed

Lessons Learned

- Dynamic simulation requirements for such process configurations.
- Mitigating actions to eliminate reverse rotation should consider:
 - ITV modification for complete closure during shutdown.
 - Installation of check valves at suction lines.
- Machines construction should include mitigating design:
 - Bidirectional seal will eliminate risk from reverse rotation.
 - Center pivot for tilting pad can accommodate reverse rotation better than offset pivot design.
 - API standard is for 3 minutes run down tank design and so, emergency DC pump is an advantage.

Conclusions

- Reverse rotation phenomena have potential to occur in the LPG refrigeration cycles.
- Reverse rotation phenomena is more common in the motor driven compressors with relatively low machine inertia.
- Detailed surveillance of coast down speed trends of new units is recommended to ensure detection of Reverse Rotation:
 - Reverse rotation phenomena may not increase vibration or axial movements above alarm values.

Thank You

Pressure trends for unit stop

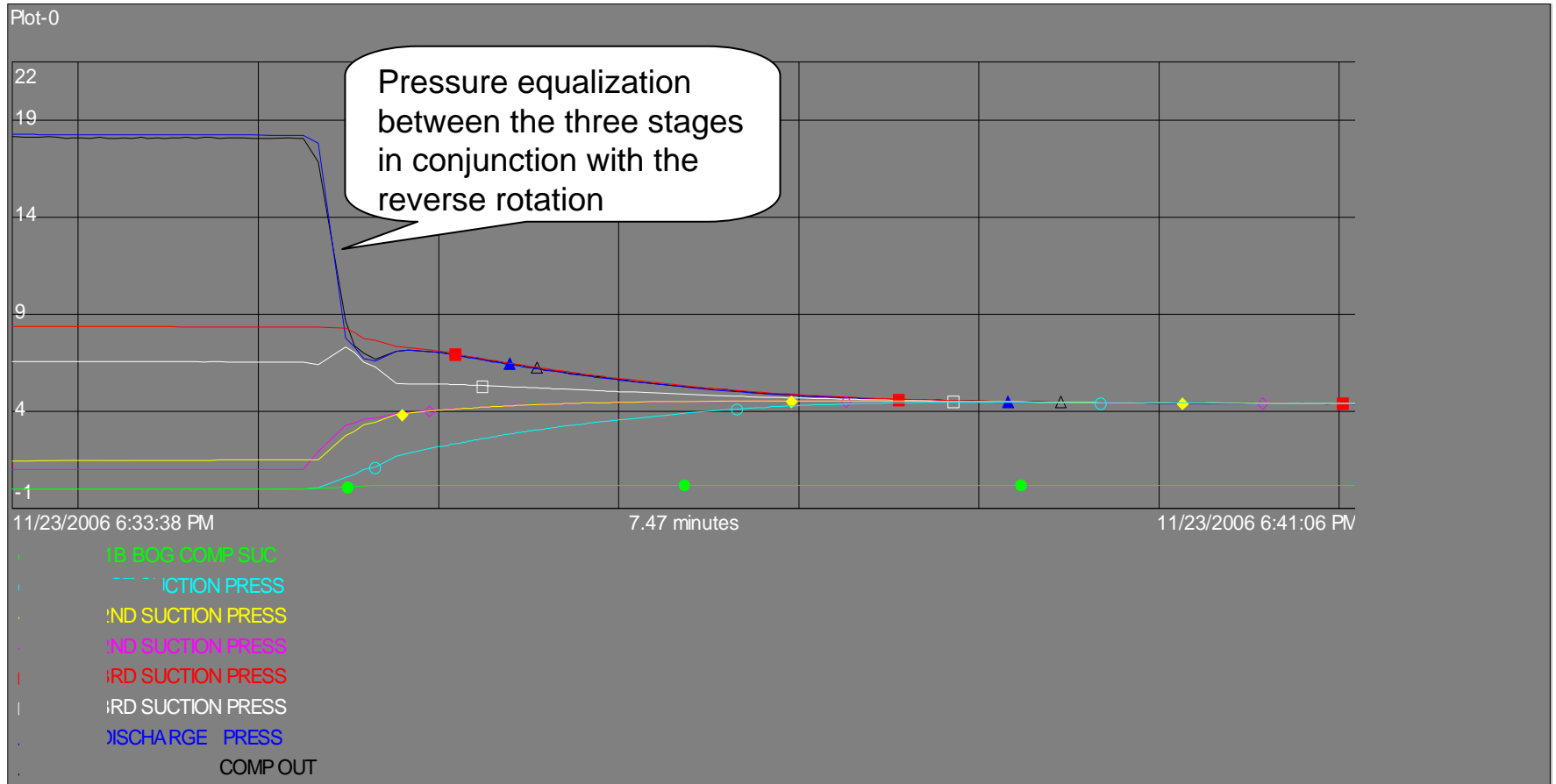

- ASV improper function is potential cause for reverse rotation during coast down.
 - Experienced in LNG BOG compressor when opening time upon shutdown is more than 2 seconds due to valves stuck or instruments failures.

