

**STATE-OF-THE-ART
FOR THE PRODUCTION OF FERTILISERS
WITH REGARD TO THE IPPC-DIRECTIVE**

Herbert Wiesenberger

MONOGRAPHIEN

Band 105

M-105

Wien, 2002

Author and Project Management

Herbert Wiesenberger

Lecturer

Andreas Hackl

Setting/Layout

Manuela Kaitna

Cover

Simplified schematic representation of the fertiliser production in a rotary granulation drum with a pipe reactor

The Federal Environment Agency – Austria would like to thank Agrolinz Melamin GmbH, Donauchemie AG and Magistrat Linz, Amt für Natur- und Umweltschutz, for their excellent co-operation.

Das Umweltbundesamt möchte sich bei der Agrolinz Melamin GmbH, bei der Donauchemie AG sowie beim Amt für Natur und Umweltschutz des Magistrat Linz für die hervorragende Zusammenarbeit herzlich bedanken.

Weitere Informationen zu Publikationen des Umweltbundesamtes finden Sie unter: <http://www.ubavie.gv.at>

Impressum

Medieninhaber und Herausgeber: Umweltbundesamt GmbH (Federal Environment Agency Ltd)
Spittelauer Lände 5, A-1090 Wien (Vienna), Austria

Druck: Manz Crossmedia GmbH & Co KG, A-1051 Wien

© Umweltbundesamt GmbH, Wien, 2002
Alle Rechte vorbehalten (all rights reserved)
ISBN 3-85457-449-5

TABLE OF CONTENTS

	Page
SUMMARY AND CONCLUSIONS	9
ZUSAMMENFASSUNG UND SCHLUSSFOLGERUNGEN	14
1 INTRODUCTION	21
1.1 Reference to the IPPC-Directive	21
1.2 Object of the Study	22
2 GENERAL INFORMATION	23
2.1 Types of Mineral Fertilisers	23
2.2 Economic Situation	24
2.2.1 Consumption and Production of Mineral Fertilisers in Europe	24
2.2.2 Consumption and Production of Mineral Fertiliser in Austria	26
2.3 Starting Materials for Fertiliser Production	28
2.3.1 Phosphate Rock	28
2.3.2 Nitric Acid	30
2.3.3 Sulphuric Acid	30
2.3.4 Ammonia	30
2.3.5 Carbon Dioxide (CO ₂)	32
2.3.6 Other Raw Materials	32
3 SSP, TSP AND MN-FERTILISER (MIXED ACID ROUTE)	33
3.1 Production Processes	33
3.1.1 Production of Single Superphosphate (SSP)	33
3.1.2 Production of Triple Superphosphate (TSP)	34
3.1.3 Production of Multi-Nutrient (MN) Fertilisers by the Mixed Acid Route	34
3.2 Resources	35
3.2.1 Input/Output Levels	35
3.2.2 Energy	36
3.2.3 Water Demand	36
3.3 Emissions to Air and Waste Gas Treatment	37
3.3.1 Main Pollutants and Emission Sources	37
3.3.2 Waste Gas Treatment	37
3.3.3 Reference Plant – Donauchemie GmbH	38
3.4 Waste Water Emissions and Waste Water Treatment	39
3.4.1 Main Pollutants and Emission Sources	39
3.4.2 Waste Water Treatment and Measures for Reduction of Waste Water Emissions	39
3.4.3 Reference Plant – Donauchemie GmbH	40
3.5 Wastes and Residues	41

4	FERTILISER PRODUCTION BY THE NITROPHOSPHATE ROUTE	42
4.1	Processes for the Production of MN-fertilisers and Conversion of Calcium Nitrate Tetrahydrate (CNTH)	42
4.1.1	Digestion of Phosphate Rock.....	43
4.1.2	Crystallisation and Filtration of Calcium Nitrate Tetrahydrate (CNTH).....	43
4.1.3	Conversion of Calcium Nitrate Tetrahydrate (CNTH)	44
4.1.4	Neutralisation/Evaporation of the Nitrophosphoric Acid.....	44
4.1.5	Spherodizer Granulation	44
4.2	Resources	45
4.2.1	Raw Material Input for the Nitrophosphate Route.....	45
4.2.2	Energy and Cooling Water Demand	46
4.3	Emissions to Air and Waste Gas Treatment	47
4.3.1	Main Pollutants and Emission Sources	47
4.3.2	Waste Gas Treatment.....	47
4.3.3	Reference Plant – Agrolinz Melamin GmbH.....	48
4.4	Waste Water Emissions and Waste Water Treatment (MN-fertiliser and CNTH conversion)	52
4.4.1	Main Pollutants and Emission Sources	52
4.4.2	Waste Water Treatment and Measures for Reduction of Waste Water Emissions	52
4.4.3	Reference plant – Agrolinz Melamine GmbH	53
4.5	Waste and Residues	55
5	AMMONIUM NITRATE AND CALCIUM AMMONIUM NITRATE	56
5.1	Production Processes	56
5.1.1	Production of Ammonium Nitrate (AN) by Neutralisation of HNO ₃ and NH ₃	56
5.1.2	Production of ammonium nitrate by the conversion of by-product CNTH from the ODDA process	56
5.1.3	Production of Calcium Ammonium Nitrate (CAN) Fertilisers	57
5.1.4	Finishing Processes	58
5.1.5	Production of Technical Grade Ammonium Nitrate	58
5.2	Resources	59
5.2.1	Input/Output Levels.....	59
5.2.2	Energy and Cooling Water.....	60
5.3	Emissions to Air and Waste Gas Treatment	61
5.3.1	Main Pollutants and Emission Sources	61
5.3.2	Air Pollution Abatement and Waste Gas Treatment.....	61
5.3.3	Reference Plant – Agrolinz Melamine GmbH.....	62
5.4	Waste Water Emissions and Waste Water Treatment	64
5.4.1	Main pollutants and emission sources.....	64
5.4.2	Measures for the Reduction of Waste Water	64
5.4.3	Reference Plant – Agrolinz Melamine GmbH.....	64

6	UREA	66
6.1	Production Processes	66
6.1.1	SNAM-Progetti Ammonia and Self Stripping Processes.....	67
6.1.2	Stamicarbon CO ₂ -Stripping Process	68
6.1.3	Evaporation and Solid Formation Processes.....	68
6.1.4	Urea – Ammonium Nitrate (UAN) Solutions	69
6.2	Resources and Energy	69
6.3	Emissions to Air and Waste Gas Treatment	69
6.3.1	Main Pollutants and Emission Sources	69
6.3.2	Waste Gas Treatment.....	70
6.3.3	Reference Plant – Agrolinz Melamine GmbH	70
6.4	Waste Water Emissions and Waste Water Treatment	72
6.4.1	Emission Sources and Main Pollutants	72
6.4.2	Emission Reduction Measures.....	72
6.4.3	Reference Plant – Agrolinz Melamine GmbH	72
7	DIFFUSE AND NON-PROCESS SPECIFIC EMISSIONS	74
7.1	Emissions to Air	74
7.2	Waste Water Emissions	74
7.3	Wastes	74
8	APPENDICES	75
8.1	Legislative Regulations for the Production of Fertilisers in Austria	75
8.1.1	Emissions to Air	75
8.1.2	General Licensing Requirements	75
8.1.3	Ambient Air Concentration and Air Quality Management Plans.....	75
8.1.4	Wastewater Regulations	76
8.1.5	Provisions according to the Seveso II-Directive	79
8.1.6	Product Regulations on Fertilisers in Austria.....	79
8.2	BAT Related Work of International Organisations – The Helsinki Convention ...	80
8.2.1	Wastewater Discharges	81
8.2.2	Emissions into the Atmosphere.....	82
8.2.3	Waste (Phosphogypsum).....	82
8.3	List of Abbreviations Used	83
8.4	Conversion Factors for Nutrients	83
9	REFERENCES	84

FIGURES AND TABLES

Figures

Figure 1: Fertiliser production and consumption in Western Europe 1990-1999 in 1000 t nutrient (N, P ₂ O ₅ , K ₂ O); Source: [FAO 2002].	24
Figure 2: Consumption of the most frequently used fertiliser types in 1.000 t nutrient (N, P ₂ O ₅ , K ₂ O) in Western Europe and Austria 1999/2000; Source: [IFA, 2002b].	25
Figure 3: Block diagram of the production of fertilisers (shaded) and of substances used for the production of fertilisers at Agrolinz Melamin GmbH	27
Figure 4: CO ₂ balance (2001) at Agrolinz Melamin in 1,000 t CO ₂ /a [Agrolinz, 2002b].	32
Figure 5: Schematic diagram of the production of single superphosphate in a den.	33
Figure 6: Schematic diagram of MN-fertiliser production (NPK and PK) in a rotary granulation drum with a pipe reactor (NPK) starting from single or triple superphosphate.	34
Figure 7: Block diagram of the NPK fertiliser production by the nitrophosphate route [Agrolinz 2001].	42
Figure 8: Example of a mass balance for the production of NP 20-20 and CAN with extra AN production referring to 1 t P ₂ O ₅ [Meyer & Nitzschmann 1998].	45
Figure 9: Multi-stage NO _x waste gas scrubbing with AN solution of the phosphate rock digestion (ODDA process) and regeneration of the scrubbing solution [Wunder 1990].	47
Figure 10: Schematic diagram of a combined scrubber for the neutralisation/evaporation exhaust vapours and the granulation off-gases of the MN-fertiliser production.	50
Figure 11: Water balance for the production of (15/15/15) NPK fertiliser (nitrophosphate route) and CAN without liquid process effluents in kg water/ton P ₂ O ₅ [Meyer & Nitzschmann, 1998].	53
Figure 12: Waste gas and waste water streams of the ODDA plant at Agrolinz Melamin GmbH before renewal of the granulation unit.	54
Figure 13: Waste gas and waste water streams of the ODDA plant at Agrolinz Melamin GmbH after renewing the granulation unit.	54
Figure 14: Block diagram of the production of CAN fertilisers by conversion of CNTH.	57
Figure 15: Schematic diagram of the production of technical grade ammonium nitrate [Krupp-Uhde 2001].	59
Figure 16: Simplified block diagram of total recycle processes, according to [Hodge & Popovici, 1994].	67

Tables

Table 1: Main mineral fertiliser types with regard to their primary nutrient composition [IFA 2002a], [EFMA 2002a].	23
Table 2: Production capacity and production of CAN and NPK fertilisers, superphosphates and other phosphate fertilisers and urea in Austria (2000) in tons product [Agrolinz 2001], [Agrolinz 2002c], [Donauchemie, 2001].	26
Table 3: Production (2001) and reserves of phosphate rock in million tons [USGS 2002] and Cd content of phosphate rock in important mines according to [Kauwenbergh 1996], [Oosterhuis et al. 2000].	29
Table 4: Environmental parameters (2001) of the Austrian Ammonia plants [Agrolinz, 2002b].	31

Table 5: Main starting materials for the production of SSP, TSP and MN-fertilisers by the mixed acid route [Donauchemie, 2001].	35
Table 6: Fertiliser production of Donauchemie [Donauchemie, 2001], [Donauchemie 2002a].	36
Table 7: Specific energy consumption for the production of MN-fertilisers [Donauchemie 2001, 2002c].	36
Table 8: Emissions into air from SSP, TSP and MN-fertiliser production (mixed acid route) [Donauchemie 2001, 2002c, 2002d].	38
Table 9: Waste water emissions arising from the production of P-fertilisers at the Austrian plant current emission limits and emission limits according to the ministerial order for the limitation of wastewater emissions from the production of inorganic fertilisers [Donauchemie 2001], [Donauchemie 2002a], [AEV Düngemittel 1996].	40
Table 10: Input for the production MN-fertilisers (ODDA process) without input for the conversion of CNTH [Agrolinz 2002c].	46
Table 11: Output (MN-fertilisers and by-product $\text{Ca}(\text{NO}_3)_2$) of the ODDA process [Agrolinz 2001, 2002a].	46
Table 12: Specific energy demand for the production of MN-fertilisers (NP and NPK) by the nitrophosphate route [Agrolinz Melamin, 2001].	46
Table 13: Emission levels of the major air emission sources of the MN fertiliser production at Agrolinz Melamine GmbH [Agrolinz 2002c], [Agrolinz 2002e], [Magistrat Linz 2002a].	49
Table 14: Design values of raw gas flow and raw gas concentration of the neutralisation/evaporation exhaust vapours and Spherodizer off-gases, which are treated together with the combined scrubber at Agrolinz Melamin GmbH [Agrolinz 2001].	51
Table 15: Economic figures of the scrubber for combined treatment of waste gases from two Spherodizers and the exhaust vapours of the neutralisation/evaporation section [Agrolinz 2002c].	51
Table 16: Economic figures of the plate bank coolers at Agrolinz Melamin GmbH [Agrolinz 2002c].	51
Table 17: Waste water emissions from the production of MN-fertilisers (including CNTH conversion) at Agrolinz Melamin GmbH, current emission limits and emission limits according to the ministerial order for the limitation of wastewater emissions from the production of inorganic fertilisers [Agrolinz 2001], [AEV Düngemittel 1996], [Magistrat Linz 2002b].	55
Table 18: Input/output levels of the ammonium nitrate production at Agrolinz Melamin GmbH [Agrolinz 2002c].	60
Table 19: Output of CAN fertiliser production at Agrolinz Melamin GmbH [Agrolinz 2001], [Agrolinz, 2002a].	60
Table 20: Specific energy consumption for the production of CAN [Agrolinz 2001].	60
Table 21: Emission levels of the major air emission sources of the production of CAN fertilisers at Agrolinz Melamin GmbH [Agrolinz 2002c], [Agrolinz 2002e], [Magistrat Linz, 2002a].	62
Table 22: Emission levels of the production of technical grade ammonium nitrate at Agrolinz Melamin GmbH [Agrolinz 2001].	63
Table 23: Investment and maintenance costs of the off-gas treatment of the technical grade ammonium nitrate production [Agrolinz 2002c].	63
Table 24: Waste water emissions from the AN pressure neutralisation at Agrolinz Melamin GmbH, current emission limits and emission limits according to the ministerial order for the limitation of wastewater emissions from the production of inorganic fertilisers [Agrolinz 2001], [Magistrat Linz 2002b], [AEV Düngemittel 1996].	65
Table 25: Dust formation from prilling of urea – causes and typical particle size range in the off-gases of prill towers [EFMA 2001b].	70

Table 26: Emission levels of the major air emission sources of the urea production at Agrolinz Melamine GmbH [Agrolinz 2002d], [Agrolinz 2002e], [Magistrat Linz 2002a].	71
Table 27: Economic figures of the off-gas treatment of the urea prill tower [Agrolinz 1999], [Agrolinz 2002d].	71
Table 28: Waste water emissions from urea production at Agrolinz Melamin GmbH, current emission limits and emission limits according to the ministerial order for the limitation of wastewater emissions from the production of inorganic fertilisers [Agrolinz 2002d], [Magistrat Linz 2002b], [AEV Düngemittel 1996].	72
Table 29: Concentrations of N-containing components in the scrubbing solution [Agrolinz, 1999].	73
Table 30: TA Luft, Figure 5.4.4.1q: Special provisions for existing installations for the production of fertilisers (straight- or multi nutrient fertiliser) containing P, N and/or K incl. ammonium nitrate and urea.	75
Table 31: Emission limits for the discharge of waste water according to the Austrian ministerial order for the limitation of wastewater emissions from the production of inorganic fertilisers as well as phosphoric acid and its salts (“AEV anorganische Düngemittel”).	77
Table 32: Total permissible input of heavy metal into agricultural soil according to the Austrian ordinance on fertilisers (Düngemittelverordnung, Federal Law Gazette 1994/1007).	80
Table 33: Limits for heavy metal contents in mineral fertilisers containing more than 5 % P ₂ O ₅ according to the Austrian ordinance on fertilisers (Düngemittelverordnung, Federal Law Gazette 1007/1994).	80
Table 34: Emission limit values for waste water emissions according to [HELCOM 1996].	81
Table 35: Recommended techniques for air pollution abatement and treatment [HELCOM 17/6].	82
Table 36: Emission limit values for emissions into air according to [HELCOM 1996].	82

SUMMARY AND CONCLUSIONS

In the following section general and process-specific measures for the reduction of waste gas and waste water emissions as well as achievable emission levels for the production of fertilisers are summarised, which should be taken into account when considering state-of-the-art¹⁾. As far as it is not explicitly noted, measures are applicable and emission levels are achievable for both new and existing plants.

A. General Emission Reduction Measures for the Production of Fertilisers

- **Raw materials:**
 - Use of phosphate rock with low impurity contents (in particular cadmium, mercury and radionuclides);
 - Avoidance of contaminated sulphuric acid for the digestion of phosphate rock.
- **Storage and transportation of raw materials, intermediates and products:**
 - Diffuse dust emissions from transportation/handling of raw materials, intermediates and production can be reduced by plant enclosure and containment of conveyers, vessels, elevators and by reduction of fall heights. Off-gases, which are collected from conveyors and elevators, are de-dusted with fabric filters and can be re-used for other operations, such as for granulation air;
 - Fabric filters are used for treatment of emissions from bagging operations, where humidities are low. Dust emissions of 5-10 mg/Nm³ (permit/emission limit according to state-of-the-art²⁾: < 20 mg/Nm³) are achievable;
 - Storage and handling of raw materials and finished products at roofed-in areas.
- **Waste gas treatment:** The following measures should be generally considered for the production of fertilisers, additionally to process-specific waste gas treatment measures (cf. items B-E):
 - Waste gases arising from the grinding of starting materials, such as phosphate rock or lime, are treated by fabric filters. Dust emissions of 5 mg/Nm³ (permit/emission limit according to state-of-the-art²⁾< 20 mg/Nm³) are achievable by this measure;
 - Application of cyclones for de-dusting of waste gas streams;
 - Application of plate bank coolers for cooling of products as far as possible;
 - Application of multistage gas scrubbers for waste gas treatment;
 - Application of droplet separators in evaporators.
- **Measures for the reduction of waste water emissions:** The following water saving measures should be generally considered for the production of fertilisers, additionally to process-specific water saving measures (cf. items B-E):
 - Application of multi-stage scrubbers for waste gas treatment;

¹⁾ In Austria state-of-the-art technologies form the legal basis for emission limit values. Therefore the term „state-of-the-art“ is used in the present report.

²⁾ The indicated emission values mostly represent emission limit values of the installations at Agrolinz Melamin GmbH. In case of state-of-the-art technologies allow for considerable lower emission levels (due to recent developments in state-of-the-art technologies, such as dust separation), lower emission limit values (according to state-of-the-art) than the current emission limits are indicated. In that case the indicated values (that are lower than current emission limits) have been agreed on by the competent authority (Magistrat Linz) and by Agrolinz Melamin GmbH. The indicated emission values are based on half-hour mean values.

- Re-circulation of liquid effluents into the process to the largest extend possible e.g. of scrubbing and washing liquors, vapours, condensates and process waters
- Multiple use of process waters in other fields of fertiliser production.
- **Waste water treatment:** For the treatment of waste water that cannot be avoided the following treatment technologies should be considered, either alone or in combination:
 - Sedimentation/filtration;
 - Concentration/evaporation preferably with subsequent re-circulation to production;
 - Precipitation of phosphate/fluoride/heavy metals by lime slurry, including multistage heavy metal precipitation with flocculation/filtration;
 - Ammonia stripping for the reduction of NH_3 emissions;
 - Biological waste water treatment with nitrification/denitrification and phosphoric precipitation;
 - Utilisation or disposal of residues arising from waste water treatment separate from waste water.

B. Production of Phosphorous Fertilisers by Phosphate Rock Digestion with H_2SO_4 and/or H_3PO_4 (incl. Production of Single Superphosphate, Triple Superphosphate and Multi-Nutrient Fertilisers by the Mixed Acid Route)

- **Waste gas emissions and waste gas treatment:** Main pollutants from the production of phosphate fertilisers by phosphate rock digestion with H_2SO_4 and/or H_3PO_4 are dust, NH_3 , HCl and fluorine compounds. HCl is released from the digestion of phosphate rock and when PK-fertilisers are produced during granulation or drying operations. NH_3 is released when NPK fertilisers are produced. Waste gases arising from the phosphate rock digestion and from granulation and drying operations are de-dusted with cyclones and treated by multistage wet scrubbing.
 - By wet scrubbing of waste gases arising from phosphate rock digestion, F-emissions of 5 mg/Nm^3 (as HF) and Cl emissions below 30 mg/Nm^3 (as HCl) are achievable.
 - By wet scrubbing of waste gases arising from product granulation and drying, F-emissions of 5 mg/Nm^3 (as HF), NH_3 -emissions of 5 mg/Nm^3 and Cl-emissions below 30 mg/Nm^3 (as HCl) are achievable.
 - Dust emissions below 50 mg/Nm^3 are state-of-the-art³⁾.
- **Waste water emissions and measures for the reduction of waste water emissions:** Potential emission sources from the production of phosphate fertilisers by phosphate rock digestion with H_2SO_4 and/or H_3PO_4 are scrubbing liquors arising from waste gas treatment. By the following process-specific water saving processes waste water emissions can be reduced:
 - Application of multistage scrubbing for waste gas treatment of the phosphate rock digestion off-gases and the granulation off-gases.
 - Reduction of fluorine emissions into water by re-circulation of scrubbing solution arising from off-gas treatment of the phosphate rock digestion into the production process or by precipitation of fluorine compounds from the scrubbing solution.
 - Waste water emissions arising from waste gas treatment of the granulation and drying operations can totally be avoided when scrubbing solutions are recycled into the production process.

³⁾ Emission limit value according to TA Luft 2002

C. Production of Multi-Nutrient Fertilisers by the Nitrophosphate Route (ODDA Process)

- **Waste gas emissions and waste gas treatment:** Main pollutants arising from multi-nutrient fertiliser production by the nitrophosphate route are dust, NO_x , NH_3 and fluorine compounds. Waste gases arising from phosphate rock digestion, from neutralisation/evaporation and from granulation and drying operations are treated by wet scrubbing.
 - At the digestion of phosphate rock with nitric acid NO_x emissions of 200-250 mg/Nm^3 on average⁴⁾ (permit/emission limit according to state-of-the-art²⁾: < 400 mg/Nm^3) and F-emissions of 0.3-0.4 mg/Nm^3 on average⁴⁾ (permit/emission limit according to state-of-the-art²⁾: < 2 mg/Nm^3) can be achieved by waste gas scrubbing and by use of phosphate rock with low contents of organic impurities and ferric salts.
 - By combined treatment of the waste gas streams from the neutralisation/evaporation and the granulation and drying units, NH_3 emissions of 30 mg/Nm^3 and dust emissions of 25 mg/Nm^3 are achievable⁵⁾. The process can be installed at new and existing nitrophosphate fertiliser plants. When comparing with other waste gas scrubbers waste water emissions have to be considered, too.
- **Waste water emissions and measures for the reduction of waste water emissions:** Potential emission sources of the nitrophosphate process are condensates from neutralisation/evaporation units, scrubbing liquors from off-gas treatment of digestion, neutralisation and granulation and washing liquors from sand washing. Main pollutants are ammonia, nitrates, fluorides and phosphates and heavy metals contained in phosphate rock, such as Cd, Hg and Zn. The following process-specific emission reduction measures should be considered for the production of multi-nutrient fertilisers by the nitrophosphate route:
 - Avoidance of antifoaming agents for the phosphate rock digestion, which contain dangerous substances;
 - Recycling of scrubbing liquor arising from treatment of the phosphate rock digestion off-gases into the production process;
 - Recycling of washing water for sand washing into the production process;
 - Avoidance of direct cooling/quenching, e.g. co-condensation of exhaust vapours;
 - Recycling of scrubbing liquor from waste gas scrubbing of the ammoniation into the production process;
 - Combined waste gas scrubbing of the neutralisation/evaporation and granulation/drying units; Due to the utilisation of the waste heat of the product granulation/drying off-gases for evaporation of liquid effluents from the neutralisation/evaporation unit, the waste water volume (from scrubbing solution and process condensate) can be reduced to a large extent, so that the concentrated scrubbing solution can be totally recycled into the production process;
 - Application of buffer reservoirs in order to compensate fluctuations of volume and load of the waste water.By the application of these or equivalent measures, waste water emissions can be reduced to a large extent in new and existing plants. Even the production of multi-nutrient fertilisers without liquid effluents is possible with adequate process design, in particular for new nitrophosphate fertiliser plants. Process water that cannot be recycled is discharged after adequate waste water treatment.

⁴⁾ Indicated emission values are annual averages on measured half-hour mean values. For further details please be referred to tables 13, 21, 22 and 26.

⁵⁾ Temporary emission limit values of the 2 years trial operation (since 9/2001); definitive setting of limit values is only possible after the end of the trial operation.

- **Conversion of calcium nitrate tetra hydrate (CNTH):** The production of nitrophosphate fertilisers by the ODDA process produces as a by-product calcium nitrate tetra hydrate (CNTH). The conversion of CNTH with NH_3 and CO_2 results in the production of ammonium nitrate solution and lime, which both are normally used for the production of calcium ammonium nitrate fertilisers. Off-gases arising from the separation of CNTH are treated together with off-gases from phosphate rock digestion.

D. Production of Ammonium Nitrate Solution and Calcium Ammonium Nitrate Fertilisers

Ammonium nitrate (AN) solution is produced by neutralisation of ammonia with nitric acid or by conversion of calcium nitrate tetra hydrate (CNTH), which is obtained as a by-product of the ODDA process (cf. item C). Calcium ammonium nitrate (CAN) fertilisers are produced from ammonium nitrate solution and ground dolomite/limestone or, quite frequently, by-product calcium carbonate from an ODDA plant. As nitrogen fertilisers based on ammonium nitrate are limited to a maximum nitrogen content of 28 % under the Austrian Fertiliser Law, the production of AN fertilisers is not taken into account within the present report. In Austria only calcium ammonium nitrate fertilisers are produced.

- **Production of ammonium nitrate solution by neutralisation:**
 - Process steam evolved from the neutralisation can be used for the subsequent concentration of the ammonium nitrate solution. The heat of reaction will be utilised most efficiently if neutralisation is carried out under pressure. Depending on operating conditions, ammonium nitrate solutions with a concentration of up to 95-97 % AN are achievable without additional energy required. For new installations pressure neutralisation can be considered state-of-the-art technology.
 - Process steam and exhaust vapours arising from the neutralisation and the evaporation units are contaminated with ammonia and ammonium nitrate, which are recovered to the largest extent possible and recycled into the synthesis, optionally after condensing steam and/or vapours. Combinations of scrubbers, droplet separators, as well as stripping with air or steam, and distillation are applied for purification of steam/exhaust vapours/condensates. When condensing steam and vapours, liquid process effluents result, which require adequate treatment. Non-condensable waste gases are treated by wet scrubbing, optionally together with waste gases from an associated CAN fertiliser plant.
 - With regard to waste water emissions, main pollutants from AN neutralisation are $\text{NO}_3\text{-N}$ and $\text{NH}_4\text{-N}$. Emission sources are condensation of steam from the neutralisation and condensation of exhaust vapours from the evaporation. By the application of closed circuits for re-circulation of concentrated process condensates into the synthesis processes and by steam/condensate purification, ammonia and ammonium nitrate can at least partly be recycled into the synthesis section. Purified process condensate can be used for waste gas scrubbing or can partly be recycled in other plants. Examples are the use of process water for a nitric acid production or for scrubbing water in a nitrophosphate plant. Process water that cannot be recycled is discharged after adequate waste water treatment.
- **Emission reduction measures for the production of CAN fertilisers**
 - Wet scrubbers provide adequate waste gas treatment for granulation and drying units. Compared to prilling the main differences of granulation with respect to waste gas treatment are that smaller off-gas volumes are treated and that the dust is coarser. Granulation should be considered state-of-the-art technology for the solidification of CAN fertilisers.

- Off-gases from granulation and drying operations are de-dusted by cyclones and treated by wet scrubbing, optionally together with non-condensable waste gases from the AN solution production. Dust emissions of 15 mg/Nm³ on average⁴⁾ (permit/emission limit according to state-of-the-art²⁾: < 25 mg/Nm³) and NH₃ emissions of 5 mg/Nm³ on average⁴⁾ (permit/emission limit according to state-of-the-art²⁾: < 20 mg/Nm³) are achievable. When producing AN solution by the conversion of CNTH, emissions of fluorine compounds have to be taken into account. With waste gas scrubbing F emissions of about 0.5 mg/Nm³ on average⁴⁾ are achievable (permit/emission limit according to state-of-the-art²⁾: < 1 mg/Nm³). Liquid effluents from waste gas scrubbing can be avoided when scrubbing solutions are recycled into the production process.
- **Emission reduction measures for the production of prilled ammonium nitrate (technical grade):** The production of technical ammonium nitrate in a prill tower evolves emissions of dust and NH₃, which can be reduced by waste gas scrubbing and recycling of cleaned air and using it for cooling air in the prill tower. By application of these measures, the waste gas volume can be reduced by about 90 %, and dust emissions of 5 mg/Nm³ on average⁴⁾ (permit/emission limit according to state-of-the-art²⁾: < 25 mg/Nm³) and NH₃ emissions below 10 mg/Nm³ on average⁴⁾ (permit/emission limit according to state-of-the-art²⁾: < 20 mg/Nm³) are achievable.

E. Production of Urea

- **Waste gas emissions and waste gas treatment:** Main emission sources from the production of urea are continuous process vents from the synthesis section containing ammonia as well as waste gases from solid formation processes (prilling or granulation) containing ammonia and dust (solid urea particles).
 - For removing ammonia emissions from continuous process vents conventional absorption equipment is used.
 - Wet scrubbers provide adequate waste gas treatment for granulation units. Scrubbing systems have proven successful in waste gas treatment of prill towers, too. Compared to granulation the main differences of prilling with respect to off-gas treatment are that large volumes of off-gas have to be treated and that very fine fume-like dust has to be removed. NH₃ emissions below the permit of 30 mg/Nm³ (annual average⁴⁾: 5-10 mg/Nm³) and dust emissions below the permit of 30 mg/Nm³ (annual average⁴⁾: 15-25 mg/Nm³) are achievable with wet scrubbing systems for the treatment of the prill tower off-gases. These values are achievable by applying an acidic (HNO₃) washing solution in order to increase the efficiency for NH₃ removal. In that case the scrubbing solution cannot be recycled into the urea production, due to the high content of ammonium nitrate. However the scrubbing solution can be recycled into other fields of fertiliser production.
- **Waste water emissions and measures for the reduction of waste water emissions:** Urea production evolves process condensate (about 300 kg/t urea) containing high concentrations of NH₃ and urea. These pollutants are recovered by a combination of hydrolysis and desorption operations in order to decompose urea and to recover ammonia and recycle it into the urea synthesis. As far as possible the use of process waters, such as scrubbing solutions in other production fields should be considered for the reduction of waste water emissions. Liquid effluents that cannot be recycled are discharged after adequate waste water treatment.

ZUSAMMENFASSUNG UND SCHLUSSFOLGERUNGEN

Im folgenden werden für die Herstellung von Düngemittel allgemeine und prozessspezifische Maßnahmen zur Reduktion von Abluft- und Abwasseremissionen sowie erreichbare Emissionswerte zusammengefasst, welche bei der Ermittlung des Standes der Technik⁶⁾ in Betracht gezogen werden sollten. Soweit nicht ausdrücklich anders vermerkt ist, beziehen sich Maßnahmen und erreichbaren Emissionswerte auf neue und bestehende Anlagen.

A. Allgemeine Maßnahmen zur Reduktion von Emissionen aus der Düngemittelherstellung

- **Rohstoffe:**
 - Einsatz von Rohphosphaten mit geringen Gehalten an Verunreinigungen (insbesondere Kadmium, Quecksilber und Radionuklide);
 - Vermeidung von kontaminierter Schwefelsäure für den Aufschluss von Rohphosphat.
- **Lagerung und Umschlag von Rohstoffen, Zwischenprodukten und Fertigprodukten:**
 - Diffuse Staubemissionen aus der Lagerung und dem Umschlag von Rohstoffen, Zwischenprodukten und Fertigprodukten können durch Einhausung von Anlagen und Einfassung von Förderbändern, Behältern und Hebewerken sowie durch die Reduktion von Fallhöhen reduziert werden. Von Förderbändern und Hebewerken erfasste Abluft wird mit Gewebefilter entstaubt und kann für andere Prozesse wie z. B. als Granulationsluft eingesetzt werden;
 - Zur Behandlung von Abluft aus Verladungsvorgängen werden bei geringen Produktfeuchten Gewebefilter eingesetzt, womit Staubemissionen von 5-10 mg/Nm³ (Auflage/Grenzwert gemäß Stand der Technik⁷⁾: < 20 mg/Nm³) erreichbar sind;
 - Lagerung und Umschlag von Rohstoffen oder Fertigprodukten erfolgt auf überdachten Flächen.
- **Maßnahmen zur Abluftbehandlung:** Zusätzlich zu prozessspezifischen Maßnahmen (vergl. B-E), sollten für die Abluftbehandlung bei der Herstellung von Düngemittel die folgenden Maßnahmen in Betracht gezogen werden:
 - Bei der Mahlung von Rohstoffen, wie z.B. Rohphosphat und Kalk werden Gewebefilter eingesetzt, womit Staubemissionen von 5 mg/Nm³ (Auflage/Grenzwert gemäß Stand der Technik⁷⁾: < 20 mg/Nm³) erreichbar sind;
 - Einsatz von Zyklonen zur (Vor)entstaubung von Abluftströmen;
 - Einsatz von Plattenwärmetauschern zur Produktkühlung, soweit möglich;
 - Einsatz von mehrstufigen Waschverfahren zur Abluftbehandlung;
 - Einsatz von Tropfenabscheidern in Eindampfanlagen.

⁶⁾ In Österreich ist für die Festlegung von Emissionsgrenzwerten der Stand der Technik maßgebend. Aus diesem Grund wird im vorliegenden Bericht der Begriff „Stand der Technik“ verwendet.

⁷⁾ Die angegebenen Emissionswerte entsprechen in der Regel den Grenzwerten der Anlagen der Agrolinz Melamin GmbH. In einzelnen Fällen sind mit Verfahren gemäß dem Stand der Technik jedoch deutlich niedrigere Emissionswerte als die bestehenden Emissionsgrenzwerte erreichbar (durch die laufende Entwicklung des Standes der Technik, wie z. B. bei der Staubabscheidung). In diesen Fällen sind Emissionsgrenzwerte entsprechend dem Stand der Technik angegeben, wobei die angegebenen Werte (welche niedriger als die bestehenden Grenzwerte sind) in Übereinstimmung mit der Behörde (Magistrat Linz) und der Agrolinz Melamin GmbH ermittelt wurden. Die angegebenen Grenzwerte basieren auf Halbstunden-Mittelwerten.

- **Maßnahmen zur Reduktion von Abwasseremissionen:** Zusätzlich zu prozessspezifischen Maßnahmen zur Reduktion von Abwasseremissionen (vergl. Punkte B-E), sollten bei Herstellung von Düngemittel wassersparenden Verfahren in Betracht gezogen werden wie z. B.:
 - Einsatz von mehrstufigen Waschverfahren zur Abluftbehandlung;
 - weitestgehende Rückführung von Abwässern, wie z. B. von Waschwässern, Brüden, Kondensaten und Prozesswässern in den Prozess;
 - Weiterverwendung von Prozessabwässern in einem anderen Herstellungsprozess.
- **Abwasserreinigung:** Für die Behandlung von nicht vermeidbaren Abwässern sollten folgende Abwasserreinigungsverfahren, entweder bei alleinigem oder bei kombiniertem Einsatz in Betracht gezogen werden:
 - Sedimentation/Filtration;
 - Konzentration/Verdampfung vorzugsweise mit anschließender Rückführung in die Produktion;
 - Abscheidung von Phosphaten/Fluoriden/Schwermetallen durch Zugabe von Kalkmilchsuspension, inkl. mehrstufige Abscheidung durch Flockung/Filtration;
 - Strippverfahren zur Reduktion von Ammoniakemissionen;
 - biologische Abwasserbehandlung mit Nitrifikation/Denitrifikation und Fällung von Phosphaten;
 - vom Abwasser gesonderte Verwertung oder Entsorgung der Rückstände aus der Abwasserbehandlung.

B. Herstellung von Phosphatdüngemittel durch Aufschluss von Rohphosphaten mit H_2SO_4/H_3PO_4 (inkl. Herstellung von einfachem Superphosphat, Triple-Superphosphat und Mehrnährstoff-Düngemittel durch den Mischsäure-Prozess)

- **Abluftemissionen und Abluftreinigung:** Wesentliche Schadstoffe aus der Herstellung von Phosphatdüngern durch Aufschluss mit H_2SO_4 und/oder H_3PO_4 sind Staub, NH_3 , HCl und HF. HCl wird beim Rohphosphataufschluss und im Fall der Herstellung von PK-Düngemittel aus der Produktgranulation und -trocknung freigesetzt. NH_3 Emissionen entstehen bei der Herstellung von NPK-Düngemittel. Abluft aus dem Rohphosphataufschluss und aus der Produktgranulation und -trocknung werden mit Zyklonen entstaubt und mit mehrstufigen nassen Wäschern behandelt.
 - Durch nasse Wäsche der Abluft aus dem Rohphosphataufschluss sind F-Emissionen von 5 mg/Nm^3 (als HF) und Cl-Emissionen unter 30 mg/Nm^3 (als HCl) erreichbar.
 - Durch nasse Wäsche der Abluft aus der Produktgranulation und -trocknung sind F-Emissionen von 5 mg/Nm^3 , NH_3 Emissionen von 5 mg/Nm^3 und Cl-Emissionen unter 30 mg/Nm^3 (als HCl) erreichbar.
 - Staubemissionen unter 50 mg/Nm^3 entsprechen dem Stand der Technik⁸⁾.
- **Abwasseremissionen und Maßnahmen zur Reduktion von Abwasseremissionen:** Mögliche Emissionsquellen bei der Herstellung von Phosphatdünger durch Aufschluss mit H_2SO_4 und/oder H_3PO_4 sind Waschwässer aus der Abluftbehandlung. Mit den folgenden prozessspezifischen wassersparenden Verfahren können Abwasseremissionen reduziert werden.

⁸⁾ Emissionsgrenzwert gemäß TA Luft 2002

- Einsatz von mehrstufigen Waschverfahren zur Reinigung der Abluft aus dem Rohphosphataufschluss und aus der Produktgranulation und -trocknung.
- Reduktion von Fluoremissionen durch Rückführung von Waschlösung aus der Abluftbehandlung des Rohphosphataufschlusses in den Herstellungsprozess oder durch Abscheidung von Fluorverbindungen aus der Waschlösung.
- Abwasseremissionen aus der Abluftreinigung der Produktgranulation und -trocknung können gänzlich vermieden werden, wenn die Waschlösungen in den Herstellungsprozess rückgeführt werden.

C. Herstellung von Mehrnährstoff-Düngemittel durch den Nitrophosphat-Prozess (ODDA-Verfahren)

- **Abluftemissionen und Abluftbehandlung:** Wesentliche Schadstoffe aus der Herstellung von Mehrnährstoff-Düngemittel mit dem Nitrophosphat-Verfahren sind Staub, NO_x , NH_3 und Fluorverbindungen. Abluftströme aus dem Rohphosphataufschluss, aus der Neutralisation/Verdampfung und aus der Produktgranulation und -trocknung werden mit nassen Waschverfahren gereinigt.
 - Beim Aufschluss von Rohphosphat mit Salpetersäure sind durch Abluftwäsche und durch den Einsatz von Rohphosphaten, welche geringe Gehalte an organischen Substanzen und Eisen(III)salzen aufweisen, im Mittel⁹⁾ NO_x Emissionen von 200-250 mg/Nm^3 (Auflage/Grenzwert gemäß Stand der Technik⁷⁾: < 400 mg/Nm^3) und im Mittel⁹⁾ F-Emissionen von 0,3-0,4 mg/Nm^3 (Auflage/Grenzwert gemäß Stand der Technik⁷⁾: < 2 mg/Nm^3) erreichbar.
 - Durch eine gemeinsame Abluftreinigung der Abluftströme aus der Neutralisation/Verdampfung und der Granulation/Trocknung mittels Wäscher können NH_3 Emissionen unter 30 mg/Nm^3 und Staubemissionen von 25 mg/Nm^3 erreicht werden¹⁰⁾. Ein derartiges Abluftreinigungsverfahren kann in neuen und bestehenden Anlagen eingesetzt werden. Beim Vergleich mit anderen Abgaswäschern sind auch Abwasseremissionen zu berücksichtigen.
- **Abwasseremissionen und Maßnahmen zur Reduktion von Abwasseremissionen:** Mögliche Emissionsquellen des Nitrophosphat-Prozesses sind Kondensate aus der Neutralisation/Verdampfung, Waschlösungen aus der Abluftreinigung von Aufschluss-, Neutralisations- und Granulationsprozessen und Waschwässer aus der Wäsche von abgetrenntem Sand. Wesentliche Abwasserinhaltsstoffe sind Ammonium, Nitrate, Fluoride und Phosphate sowie im Rohphosphat enthaltene Schwermetalle, wie z. B. Cd, Hg und Zn. Folgende prozessspezifische Maßnahmen zur Emissionsminderung sollten bei der Herstellung von Mehrnährstoff-Düngemittel durch den Nitrophosphat-Prozess in Betracht gezogen werden:
 - Verzicht auf den Einsatz von Entschäumungsmitteln im Aufschlussprozess, die Stoffe mit gefährlichen Eigenschaften enthalten;
 - Rückführung von Waschlösung aus der Abluftbehandlung des Rohphosphataufschlusses in den Herstellungsprozess;
 - Rückführung der Waschwässer aus der Sandwäsche in den Produktionsprozess;
 - Vermeidung von direkter Kühlung/Quenchen, wie z. B. Mischkondensation von Brüden;
 - Rückführung der Waschlösung aus der Abluftbehandlung der Ammonisierung in den Produktionsprozess;

⁹⁾ Die angegebenen Emissionswerte sind Jahresmittelwerte, welche auf Basis der gemessenen Halbstunden-Mittelwerte ermittelt wurden (für detaillierte Angaben vgl. Tabellen 13, 21, 22 und 26)

¹⁰⁾ Vorläufige Grenzwerte des zweijährigen Versuchsbetriebes; Eine endgültige Festlegung ist erst nach Ablauf des Versuchsbetriebes möglich.

- Gemeinsame Abluftwäsche der Neutralisation/Verdampfung und der Produktgranulation/-trocknung; Durch die Nutzung von Abwärme aus der Produktgranulation/-trocknung für die Verdampfung von Wässern aus der Neutralisation/Verdampfung ist eine Reduktion des Abwasservolumens (Waschlösung und Prozesskondensate) möglich, sodass die konzentrierte Waschlösung vollständig in den Herstellungsprozess rückgeführt werden kann.
- Einsatz von Pufferbecken zwecks Ausgleich von Abwassermengenschwankungen und Schmutzfrachtschwankungen.
Mit dem Einsatz dieser oder ähnlich wirksamer Maßnahmen in neuen und bestehenden Anlagen können Abwasseremissionen weitgehend reduziert werden. Insbesondere in neuen Nitrophosphat-Anlagen ist bei entsprechender Verfahrensführung auch eine abwasserfreie Herstellung von Mehrnährstoff-Düngemittel möglich. Nicht rückführbare Abwässer werden nach einer entsprechenden Behandlung abgeleitet.
- **Umwandlung von Kalziumnitrat-Tetrahydrat:** Bei der Herstellung von Nitrophosphat-Düngemittel durch das ODDA Verfahren fällt als Nebenprodukt Kalziumnitrat-Tetrahydrat an. Durch Umwandlung von Kalziumnitrat-Tetrahydrat mit NH_3 und CO_2 wird Ammoniumnitratlösung und Kalk hergestellt, welche üblicherweise zu Kalzium-Ammoniumnitrat-Düngemittel weiterverarbeitet werden. Abluft aus der Abtrennung von Kalziumnitrat wird zusammen mit Abluft aus dem Rohphosphataufschluss behandelt.

D. Herstellung von Ammoniumnitratlösung und Kalzium-Ammoniumnitrat Düngemittel

Ammoniumnitrat (AN) Lösung wird durch Neutralisation von Ammoniak mit Salpetersäure, oder durch Umwandlung von Kalziumnitrat-Tetrahydrat (CNTH), welches als Nebenprodukt des ODDA Prozesses anfällt (vergl. Punkt C), hergestellt. Kalzium-Ammoniumnitrat (CAN) Düngemittel werden aus Ammoniumnitratlösung und gemahlene Kalkstein bzw. in vielen Fällen aus Kalk, welches als Nebenprodukt aus dem ODDA Prozess anfällt, hergestellt. Auf die Herstellung von Ammoniumnitrat Düngemittel wird im Rahmen dieses Berichts nicht näher eingegangen, da Stickstoffdüngemittel auf Basis Ammoniumnitrat durch das österreichische Düngemittelgesetz mit einer maximalen Stickstoffkonzentration von 28 % begrenzt sind. Aus diesem Grund werden in Österreich ausschließlich Kalzium-Ammoniumnitrat Düngemittel hergestellt.

- **Herstellung von Ammoniumnitratlösung durch Neutralisation:**
 - Der aus dem Neutralisator freigesetzte Prozessdampf kann für die nachfolgende Eindampfung der Ammoniumnitrat Lösung verwendet werden. Die Reaktionswärme wird dabei am effizientesten genutzt, wenn die Neutralisation unter Druck ausgeführt wird. In Abhängigkeit der Betriebsbedingungen kann ohne weitere Energiezufuhr eine Ammoniumnitrat Lösung mit einer Konzentration von bis zu 95-97 % AN erreicht werden. Für Neuanlagen kann die Druckneutralisation als Stand der Technik erachtet werden.
 - Prozessdampf aus der Neutralisation und Brüden aus dem Eindampfen der Ammoniumnitrat Lösung sind mit Ammoniak und Ammoniumnitrat verunreinigt. Ammoniak und Ammoniumnitrat werden, gegebenenfalls nach der Kondensation von Dampf bzw. Brüden, weitestgehend rückgewonnen und in den Syntheseprozess rückgeführt. Zur Reinigung von Prozessdampf/Brüden/Kondensaten werden Kombinationen aus Wäschern und Tropfenabscheidern sowie Strippenverfahren mit Luft oder Dampf und Destillation eingesetzt. Durch die Kondensation von Prozessdampf und Brüden entstehende Abwässer sollten einer geeigneten Abwasserbehandlung zugeführt werden. Nicht kondensierbare Abluft wird durch nasse Wäsche gereinigt, gegebenenfalls zusammen mit Abluft einer zugehörigen CAN Düngemittelproduktion.

- Wesentliche Abwasserinhaltsstoffe aus der AN Herstellung durch Neutralisation sind $\text{NO}_3\text{-N}$ und $\text{NH}_4\text{-N}$. Emissionsquellen sind Prozessdampfkondensate aus der Neutralisation und Brüdenkondensate aus dem Eindampfen von Ammoniumnitratlösung. Durch die Einrichtung von geschlossenen Kreisläufen zur Rückführung von konzentrierten Prozesskondensaten in die Synthese und durch Reinigung von Dampf und Kondensaten kann Ammoniak und Ammoniumnitrat zumindest teilweise in den Herstellungsprozess rückgeführt werden. Gereinigtes Prozesskondensat kann zur Abluftwäsche oder zum Teil in anderen Anlagen eingesetzt werden. Beispiele dafür sind die Nutzung von Prozesswasser für die Herstellung von Salpetersäure oder als Waschlösung für die Abluftbehandlung in einer Nitrophosphatanlage. Prozesswasser, welches nicht rückgeführt werden kann, wird nach entsprechender Behandlung abgeleitet.
- **Maßnahmen zur Reduktion von Emissionen aus der Herstellung von Kalzium-Ammoniumnitrat Düngemittel**
 - Für die Abluftbehandlung von Granulations- und Trocknungsaggregaten sind nasse Wäscher geeignet. Hinsichtlich der Abluftreinigung weisen Granulationsverfahren verglichen mit Prillverfahren wesentlich geringere Abluftmenge und grobkörnigeren Staub auf. Granulation sollte für die Verarbeitung zu festen CAN Düngemittel als Stand der Technik in Betracht gezogen werden.
 - Abluft aus Granulations- und Trockenverfahren wird mit Zyklonen entstaubt und mit nassen Wäschern gereinigt, gegebenenfalls zusammen mit nicht kondensierbarer Abluft aus der Herstellung von AN Lösung. Im Mittel⁹⁾ sind Staubemissionen von ca. 15 mg/Nm^3 (Auflage/Grenzwert gemäß Stand der Technik⁷⁾: 25 mg/Nm^3) und NH_3 Emissionen von ca. 5 mg/Nm^3 (Auflage/Grenzwert gemäß Stand der Technik⁷⁾: $< 20 \text{ mg/Nm}^3$) erreichbar. Bei der Herstellung von AN Lösung aus der Umwandlung von Kalziumnitrat-Tetrahydrat sind zusätzlich F-Emissionen zu beachten. Mit nassen Wäschern sind im Mittel⁹⁾ F-Emissionen von $0,5 \text{ mg/Nm}^3$ (Auflage/Grenzwert gemäß Stand der Technik⁷⁾: $< 1 \text{ mg/Nm}^3$) erreichbar. Abwässer aus der Abluftbehandlung können durch Rückführung der Waschwässer in den Herstellungsprozess vermieden werden.
- **Maßnahmen zur Reduktion von Emissionen aus der Herstellung von technischem Ammoniumnitrat:** Bei der Herstellung von technischem Ammoniumnitrat in einem Prillturm werden Staub- und NH_3 -Emission freigesetzt. Diese Emissionen können durch Abluftwäsche und Rückführung der gereinigten Abluft bzw. Wiedereinsatz als Kühlluft im Prillturm reduziert werden. Mit dem Einsatz derartiger Maßnahmen können das Abluftvolumen um 90 % reduziert und im Mittel⁹⁾ Staubemissionen von 5 mg/Nm^3 (Auflage/Grenzwert gemäß Stand der Technik⁷⁾: $< 25 \text{ mg/Nm}^3$) und NH_3 Emissionen unter 10 mg/Nm^3 (Auflage/Grenzwert gemäß Stand der Technik⁷⁾: $< 20 \text{ mg/Nm}^3$) erreicht werden.

E. Herstellung von Harnstoff

- **Abluftemissionen und Abluftbehandlung:** Wesentliche Emissionsquellen aus der Herstellung von Harnstoff sind das Freisetzen von Ammoniak durch kontinuierliches Ausschleusen von Inertgasen aus der Synthese sowie ammoniak- und staubhaltige Abluft aus der Verarbeitung von Harnstofflösungen zu festem Endprodukt (Prilling oder Granulation).
 - Zur Abscheidung von Ammoniakemissionen aus kontinuierlich ausgeschleusten Inertgasen werden konventionelle Absorptionseinrichtungen eingesetzt.
 - Für die Abluftbehandlung von Granulationsaggregaten sind nasse Wäscher geeignet. Mit Waschsystemen ist eine Abluftbehandlung von Prilltürmen ebenfalls möglich. Hinsichtlich der Abluftreinigung bestehen wesentliche Unterschiede von Prillen im Vergleich zu Granulieren darin, dass große Abluftmengen behandelt werden müssen und dass sehr feine Stäube abgeschieden werden müssen. Mit Waschsystemen für die Behandlung von

Prillturmbablufte sind im Mittel⁹⁾ NH_3 Emissionen von ca. 10 mg/Nm^3 erreichbar. Einzelne Halbstundenmittelwerte können aber bis 30 mg/Nm^3 (Behördenauflage) betragen. Die Staubemissionen werden durch das WaschsysteM des Prillturms im Mittel⁹⁾ auf $15\text{--}25 \text{ mg/Nm}^3$ reduziert. Einzelne Halbstundenmittelwerte können bis 30 mg/Nm^3 (Behördenauflage) betragen. Um diese Werte zu erreichen bzw. um die Effizienz der Ammoniakabscheidung zu erhöhen, werden zur Abluftwäsche der Endverarbeitungsschritte (Prillen oder Granulieren) saure Waschlösungen (HNO_3) eingesetzt. In diesem Fall ist auf Grund der hohen Ammoniumnitratkonzentration eine Rückführung in die Harnstoffsynthese nicht möglich. Die Waschlösung kann jedoch in einem anderen Düngemittelherstellungsprozess wiedereingesetzt werden.

- **Abwasseremissionen und Maßnahmen zur Reduktion von Abwasseremissionen:** Bei der Herstellung von Harnstoff entstehen Prozesskondensate (ca. $300 \text{ kg H}_2\text{O/t}$ Harnstoff), welche hohe Konzentrationen an NH_3 und Harnstoff aufweisen. Zur Zersetzung von Harnstoff und zur Abscheidung und Rückführung von Ammoniak wird eine Kombination von Hydrolyse- und Desorptionsverfahren eingesetzt. Zur Reduktion von Abwasseremissionen kann darüber hinaus der Einsatz von Betriebsabwässern, wie z. B. Waschwässern, in anderen Herstellungsbereichen in Betracht gezogen werden. Abwässer, welche nicht rückgeführt werden können, werden nach entsprechender Behandlung abgeleitet.

1 INTRODUCTION

1.1 Reference to the IPPC-Directive

According to Art. 2 Number 11 of the European Council Directive on Integrated Pollution Prevention and Control IPPC (Directive 96/61/EC of 24 September 1996) “best available technique“ shall mean the most effective and advanced stage in the development of activities and their methods of operation which indicate the practical suitability of particular techniques for providing in principle the basis for emission limit values designed to prevent and, where that is not practicable, generally to reduce emissions and the impact on the environment as a whole.

The term “techniques” shall include both the technology used and the way in which the installation is designed, built, maintained, operated and decommissioned.

“Available” techniques shall mean those developed on a scale, which allows implementation in the relevant industrial sector, under economically and technically viable conditions, taking into consideration the costs and advantages, whether or not the techniques are used or produced inside the Member State in question, as long as they are reasonably accessible to the operator.

“Best” shall mean most effective techniques in achieving a high general level of protection of the environment as a whole.

According to the European Council Directive 96/61/EC concerning integrated pollution prevention and control Annex IV, the following considerations should be taken into account when determining best available techniques:

- the use of low-waste technologies;
- the use of less hazardous technologies;
- the furthering of recovery and recycling of substances generated and used in the process and of waste, when appropriate;
- comparable processes, facilities or methods of operations which have been tried with success on an industrial scale;
- technological advances and changes in scientific knowledge and understanding;
- the nature, effects and volume of emissions concerned;
- the commissioning dates for new or existing installations;
- the length of time needs to introduce the best available technique;
- the consumption and nature of raw materials (including water) used in the process and their energy efficiency;
- the need to prevent or reduce to a minimum the overall impact of emissions on the environment and the risks to it;
- the need to prevent accidents and to minimise the consequences for the environment;
- the information published by the Commission pursuant to Article 16 (2) or by international organisations.

According to Art. 16 Number 2 of the Council Directive 96/61/EC of 24 September 1996 concerning integrated pollution prevention and control (IPPC), the European Commission organises an exchange of information between Member States and the industry concerned on the best available techniques, associated monitoring, and developments in these areas.

Structure for the information on BAT is based on the Information Exchange Forum (IEF), on Technical Working Groups (TWG's) and on the European Integrated Pollution Prevention and Control Bureau (EIPPCB). The IEF is the co-ordination forum for the information exchange on BAT. The IEF evaluates the results of the exchange of information as presented in the form of draft IPPC BAT reference documents (BREF's). The TWG's are groups of experts established by the Commission after consultation with the IEF to carry out the detailed work for the exchange of information for given industrial activities. The EIPPCB provides the TWG's with technical and administrative support. The EIPPCB is located at the Institute for Prospective Technology Studies IPTS in Seville.

1.2 Object of the Study

The study deals with starting materials, technologies and emissions at the production of fertilisers. The present study is intended to contribute to the work of the TWG Large Volume Inorganic Chemicals – Ammonia, Acids and Fertiliser (LVIC-AAF). The present study will focus on the specific situation in Austria and is intended to provide reference data on specific processes and emission reduction measures. An essential feature of the study is to point out potential of emission reduction.

2 GENERAL INFORMATION

2.1 Types of Mineral Fertilisers

Mineral fertilisers contain one or more primary (major) nutrients N, P, K in inorganic form or as urea or cyanamide [IFA 2002a]. The primary nutrients N, P, K are required by plants in large or moderate amounts. Depending on the formulation mineral fertilisers also contain other nutrients required by plants to a minor degree, such as Ca, Mg, and S. Trace elements required in small quantities are B, Cl, Cu, Fe, Mn, Mo, Zn. Fertilisers are classified as follows in terms of their major nutrient contents [Scherer et al., 2000]:

- **Straight fertilisers** generally contain only one mayor (primary) nutrient.
- **Multi-nutrient fertilisers (MN-fertilisers)** or compound fertilisers contain two or more major nutrients. The term complex fertiliser refers to a compound fertiliser formed by mixing ingredients that react chemically.

Table 1 presents a summary of the most important fertilisers with regard to their primary nutrient composition.

Table 1: Main mineral fertiliser types with regard to their primary nutrient composition [IFA 2002a], [EFMA 2002a].

Nutrient	Fertiliser type	primary nutrient composition		
		% N	% P ₂ O ₅	% K ₂ O
N (straight)	Ammonium sulphate (AS)	21		
	Calcium ammonium nitrate (CAN)	25–28		
	Ammonium nitrate (AN)	33.5–34.5		
	Nitrogen solutions (mainly UAN)	28–32		
	Urea	46		
P (straight)	Basic slag		12–18	
	Single superphosphate (SSP)		18–20	
	Rock phosphate (raw)		26–37	
	Triple superphosphate (TSP)		45	
K (straight)	Potassium chloride (KCl)			40–60
NP	Mono ammonium phosphate (MAP)	11	52	
	Di ammonium phosphate (DAP)	16–18	42–48	
	NP-fertiliser	20–26	6–34	
PK	PK-fertiliser		5–30	5–30
NPK	Compound fertilisers and complex fertilisers	5–25	5–24	5–24

Solid fertilisers are the most important group of fertilisers in Europe. Solid fertilisers include granular, prilled, and compacted products. **Granular fertiliser** are composed of spheroid particles, usually 1.5–5 mm in diameter, and are formed by any of a number of granulation processes. **Prilled fertiliser** are of nearly spherical form and made by the solidification of free-falling droplets [IFA 2002a].

2.2 Economic Situation

2.2.1 Consumption and Production of Mineral Fertilisers in Europe

Figure 1 presents production and consumption of fertilisers in Western Europe¹¹⁾ between 1990 and 1999 according to [FAO 2002]. In the early 1990s total fertiliser consumption showed a significant decrease. The result of this decrease was a production over-capacity. Additionally, imports from producers of Eastern Europe and the former Soviet Union led to a downward pressure on prices. As a consequence, the fertiliser industry had to reduce its production capacity during a major restructuring, which led to a reduction of N-fertiliser capacities by 25 % and P-fertiliser capacities by 33 % [EFMA 1997]. Since 1992/93 consumption of P-fertilisers and K-fertilisers have more or less stabilised and consumption of N-fertiliser has slightly increased. According to [EFMA 2002b] the EU fertiliser industry has now emerged from its restructuring and can be regarded as viable and internationally competitive, although profitability remains modest [Oosterhuis et al. 2000]. The market of nitrogen fertiliser is now well balanced within the EU and Central Europe [Agrolinz 2001b]

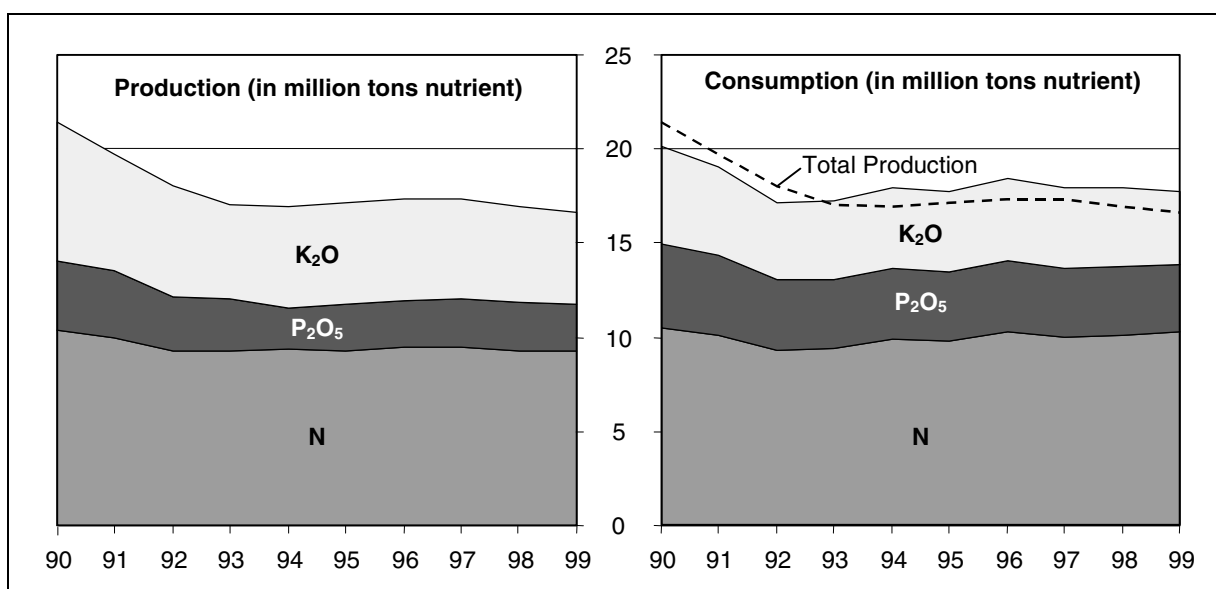

Figure 1: Fertiliser production and consumption in Western Europe 1990-1999 in 1000 t nutrient (N, P₂O₅, K₂O); Source: [FAO 2002].

Figure 2 (left part) presents the consumption of the most frequently used fertiliser types in 1,000 t nutrient (N, P₂O₅, K₂O) in West Europe according to [IFA 2002].

In Western Europe straight nitrogen fertilisers are dominating with regard to N-fertilisers. Most frequently used N-fertilisers are CAN, AN and urea. About 1/4 of N-fertilisers used in Europe are MN-fertilisers, mainly of the NPK type.

MN-fertilisers (NPK, NP and PK) dominate with regard to P-fertilisers. The importance of low-grade phosphate fertilisers (in particular single superphosphate and basic slag) has declined significantly over the last decade [Brentall, 2000].

Most frequently used K-fertiliser are NPK and PK fertilisers.

¹¹⁾ EU 15 incl. Andorra, Island, Malta, Monaco, Norway, Switzerland, Liechtenstein, San Marino

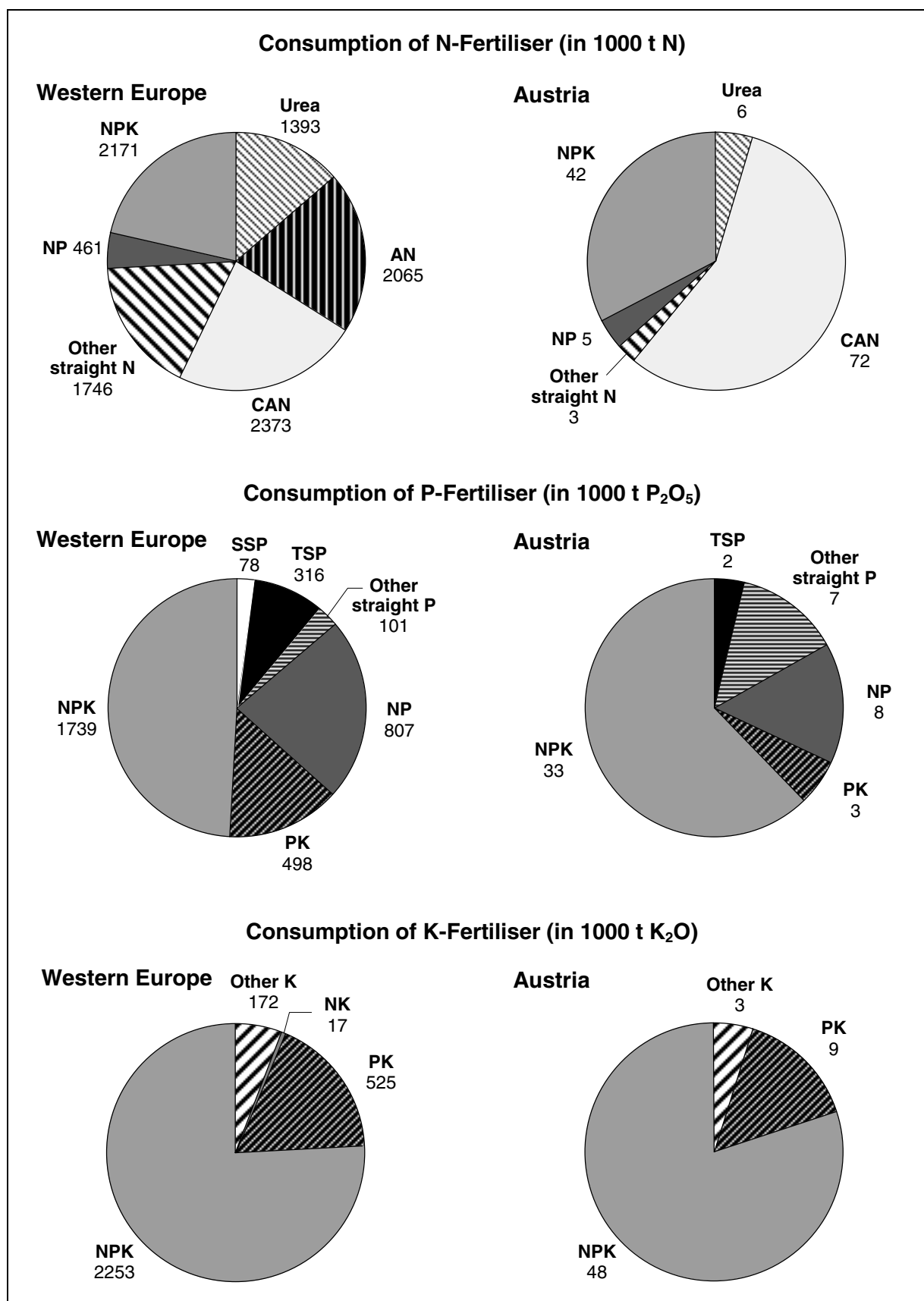

Figure 2: Consumption of the most frequently used fertiliser types in 1.000 t nutrient (N, P₂O₅, K₂O) in Western Europe and Austria 1999/2000; Source: [IFA, 2002b].

2.2.2 Consumption and Production of Mineral Fertiliser in Austria

With regard to primary nutrients (N, P, K), fertiliser consumption amounted to 128,000 tons N, 53,000 tons P₂O₅ and 60,000 tons K₂O in 1999/2000. Fertiliser production amounted to 273,000 tons N and 65,000 tons P₂O₅ in 1999/2000 [FAO 2002]. Aggregated values for the production of K-fertilisers are not available from [FAO 2002]. According to statistics of [IFA 2002b], nitrogen fertiliser consumption has more or less been constant in the last decade with some peaking in 1990/91 and in 1996/97. In the same period, the consumption of phosphate and potash fertilisers showed a significant decrease.

Figure 2 (right part) presents the **fertiliser consumption** of the most frequently used fertiliser types in Austria. CAN is the most important nitrogen fertiliser. AN fertilisers are not produced in Austria, as nitrogen fertilisers based on ammonium nitrate are limited to a maximum nitrogen content of 28 % under the Austrian Fertiliser Law. With regard to the consumption of P-fertilisers and K-fertilisers, multi-nutrient fertilisers (NPK, NP and PK) are dominating. Only 15 % of P-fertilisers are applied in form of straight P-fertilisers, such as triple superphosphate (TSP), phosphate rock for direct application, and basic slag. Single superphosphate (SSP) is no longer used as straight fertiliser. However, it is an important starting material for the production of MN-fertiliser (cf. chapter 3).

Table 2 summarises the **production of mineral fertiliser** in Austria. Mineral fertilisers are produced at two sites by two companies.

Table 2: Production capacity and production of CAN and NPK fertilisers, superphosphates and other phosphate fertilisers and urea in Austria (2000) in tons product [Agrolinz 2001], [Agrolinz 2002c], [Donauchemie, 2001].

	Agrolinz Melamin GmbH		Donauchemie AG	
	production [t/a]	capacity [t/d]	production [t/a]	capacity [t/d]
CAN fertiliser	635,000 ^{a)}	2,200		
NPK	325,000 ^{a) b)}	1,200 ^{b)}	106,000 ^{c)}	500 ^{c)}
Urea	400,000	1,400		
UAN (Urea-ammonium nitrate solution)	6,400	100		
PK-fertiliser			52,000	1,000
Single superphosphate (SSP) ^{d)}			50,000	700
Triple superphosphate (TSP)			5,600	500
Hyper-phosphate fertiliser (Phosphate rock for direct application)			50,000	300

^{a)} Production 2001

^{b)} Nitrophosphate route

^{c)} Mixed acid route

^{d)} Mainly used as starting material for the production of NPK-fertiliser

Donauchemie AG (Pischelsdorf/Lower Austria) produce fertilisers mainly starting from phosphate rock and sulphuric acid and/or phosphoric acid. At Pischelsdorf, installations for the production of sulphuric acid (double contact plant), single and triple superphosphate, compound fertilisers (PK and NPK) and hyperproducts (phosphate rock for direct application), gypsum and activated carbon are operated.

Agrolinz Melamin GmbH (Linz/Upper Austria) is a large integrated fertiliser plant. At Linz, installations for the production of ammonia, nitric acid, calcium ammonium nitrate fertilisers, technical grade ammonium nitrate, urea, compound fertilisers (NPK and NP), ammonium nitrate-urea solutions and melamine are operated.

Figure 3 presents a simplified schematic representation of the production of fertilisers and precursors at Agrolinz Melamine GmbH. The figure shows a high degree of integration between the production processes of NH_3 , HNO_3 and fertilisers NPK, CAN and urea, which is also used for melamine production.

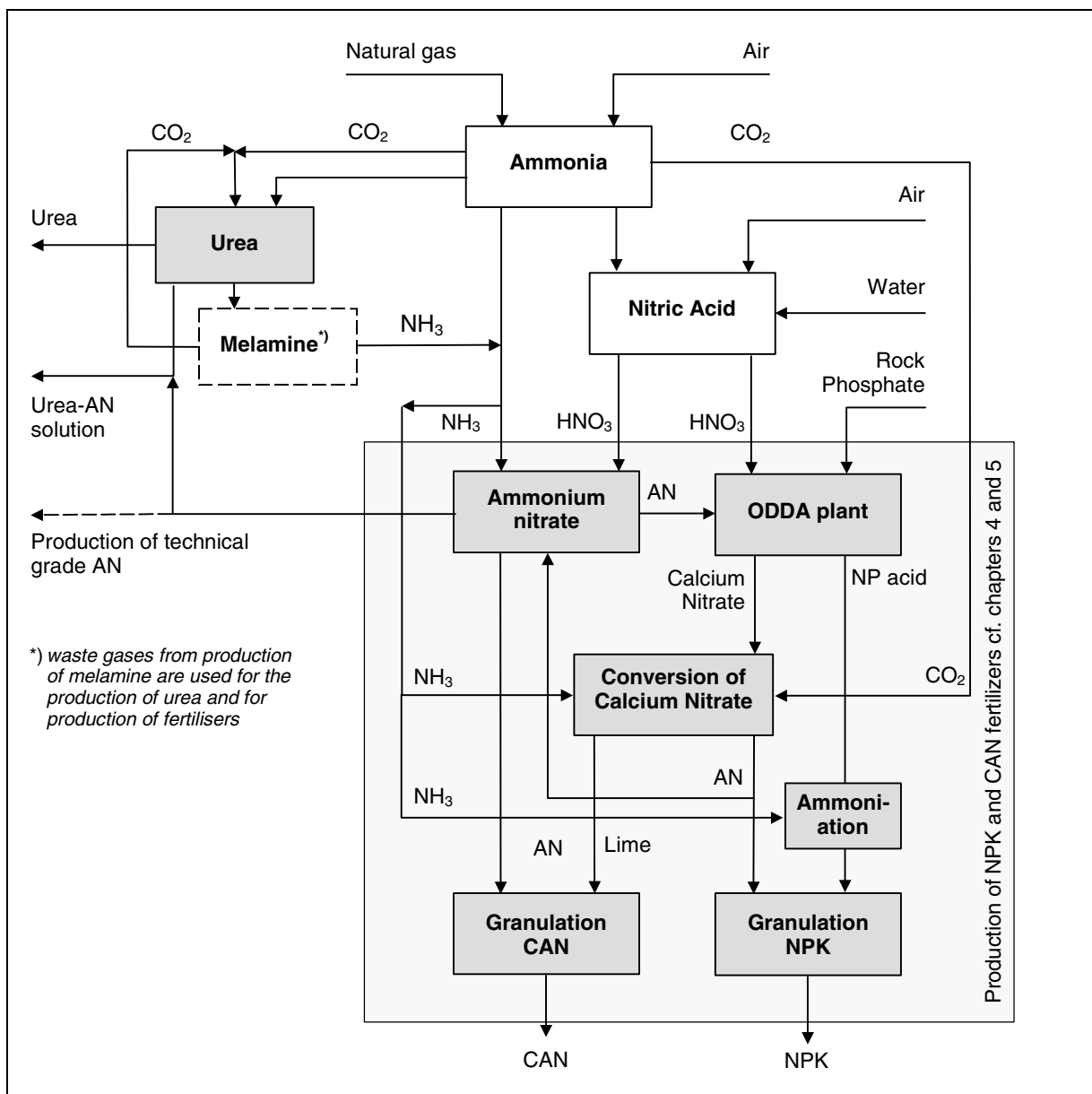

Figure 3: Block diagram of the production of fertilisers (shaded) and of substances used for the production of fertilisers at Agrolinz Melamin GmbH

In Austria, **calcium ammonium nitrate (CAN)** is the quantitatively most important fertiliser. Calcium ammonium nitrate fertilisers (CAN) are produced by mixing ammonium nitrate solution obtained from the neutralisation of NH_3 and HNO_3 and from the conversion of calcium nitrate tetra hydrate (which is a by-product of the ODDA process) with by-product calcium carbonate, which also is obtained from the ODDA process. AN fertilisers are not produced, as nitrogen fertilisers based on ammonium nitrate are limited with a maximum nitrogen content of 28 % by Austrian Fertiliser Law (cf. chapter 8.1.6).

Compound fertilisers (NPK, PK and NP) are produced by the nitrophosphate route (Agrolinz Melamin GmbH) and by the mixed acid route starting from SSP and TSP (Donauchemie AG).

Single superphosphate (SSP) and triple superphosphate (TSP) are produced alternately in a single installation by Donauchemie AG. Superphosphates are mainly used as starting material for the production of NPK fertilisers. **Phosphate rock for direct application** (hyper product) is also produced by Donauchemie AG.

Urea is produced by one plant with a capacity of 1,400 t/d. Total annual production is about 400,000 t/a. Urea is used for melamine production, for fertilisers and other purposes. **UAN solution** is produced from urea and AN.

2.3 Starting Materials for Fertiliser Production

2.3.1 Phosphate Rock

The global production of phosphate rock ore amounted to 132.9 million tons in 2000, falling to 128.2 million tons in 2001. World phosphate export is dominated by mines of Morocco, the United States, and Jordan [USGS, 2002]. For the annual production of fertilisers in Western Europe, about 12 Million tons phosphate rock are required [IFA 2002]

The composition of phosphate rock depends on the place of origin. Phosphate rock mainly consists of calcium phosphates as apatites, mainly fluorapatites. Phosphate rocks can be broadly divided into two classes – sedimentary phosphate rocks and igneous phosphate rocks. The world production mix is almost 7/8 sedimentary rocks and about 1/8 igneous rock [Kauwenbergh, 1997].

According to [Kauwenbergh, 1997] about 16 elements associated with phosphate rock and fertilisers are potentially hazardous to human health. The more common potentially hazardous elements compared with an average shale are As, Cd, Se, and U. The most enriched potentially hazardous elements in sedimentary rock are Cd (enrichment factor about 69 times) and U (enrichment factor about 30 times). The average contents of Cd, Cr, Hg, V and U in sedimentary phosphate rocks are significantly higher than those in igneous phosphate rocks. With regard to the impact of fertiliser use on heavy metals build-up in soils, the element cadmium is of primary concern. Phosphate fertilisers are the major source of environmental Cd, and its accumulation in soils from the long-term application of P fertilisers is now well documented in several countries.

In order to reduce accumulation in soils, the concentration of cadmium in phosphate fertilisers can be reduced by using low-Cd phosphate rock. The amount of Cd in phosphate rock depends on the origin of the rock.

Table 3 presents production and reserves of phosphate rock and Cd content of phosphate rock in important mines.

In Austria, limit values apply to the Cd concentration in fertilisers (cf. chapter 8.1.6). In order to apply with the legal regulations, Austrian producers use phosphate rock with low Cd contents [Donauchemie 2001], [Agrolinz 2001].

Table 3: Production (2001) and reserves of phosphate rock in million tons [USGS 2002] and Cd content of phosphate rock in important mines according to [Kauwenbergh 1996], [Oosterhuis et al. 2000].

Origin	Production (Mio. tons/a)	Reserves ^{a)} (Mio. tons)	Mine/ Region	Cadmium in Phosphate Rock			
				[Kauwenbergh 1996]	[Davister 1996] ^{c)}	[Botschek, v. Balken 1999] ^{c)}	[Demandt, 1999] ^{c)}
				(ppm) ^{b)}	(mg/kg P ₂ O ₅)		
USA	34.2	1,000	Florida	6.1-9.1	23	20-33	24
			North Carolina	38.2	166	125	120
Morocco	22.0	5,700	Khouribga ^{d)}	15.1	46	17-63	55
			Youssoufia ^{d)}	29.2	121	165	120
			Bu-Cra ^{d)}	37.5	100	101-115	97
China	20.0	1,000		2.5			
Russia	10.5	200	Kola ^{e)}	1.25	< 13	0.3	0.25
Tunisia	8.1	100	Gafsa	39.5	137	94	173
Jordan	5.5	900		5.4	< 30	12.1-28	18
Israel	4.0	180	Nahal Zin	30.8	100	81-112	61
S. Africa	2.8	1,500	Pharlaborwa ^{e)}	1.3	< 13	0.1	0.38
Syria	2.1	100		3.0	52	13-46	22
Senegal	2.0	50	Taiba	86.7	203	165-181	221
Togo	0.8	30		58.4	162	164-179	147
Others	16.2	1,240					
World	128,2	12,000					

^{a)} Amount which could be economically extracted or produced at the time of determination [USGS 2002].

^{b)} Average values

^{c)} Cited in [Oosterhuis et al. 2000]

^{d)} Reserves of phosphate rock in Morocco: Khouribga (~40%); Youssoufia (~35%); Bu-Cra (~1.5%) [OCP 2002]

^{e)} Igneous phosphate rock

As an alternative to using low-Cd rock, a possible route towards phosphate fertiliser with a lower cadmium content would be the development of commercially viable processes to remove cadmium from the phosphate rock or from the phosphoric acid. Several of such processes are currently under development, but none of them are commercially operational at the industrial level (except for food grade phosphoric acid) [Oosterhuis 2000]. According to [Syers 2001a] two approaches to the decadmiation of phosphorus fertiliser are considered:

- Reduction of the cadmium content of phosphate rock by calcination
- Removal of cadmium from phosphoric acid by a range of physical-chemical processes; Of these, anhydrite co-crystallisation appears to be the most promising, although recently there has been interest in membrane technology separation [Syers 2001a].

The cost of removing cadmium (decadmiation) from phosphate rock and phosphoric acid is considered to be substantial and has been estimated at between US\$ 23 and US\$ 46/ton P at the primary production stage [Van Kauwenburgh, 2001]. There are presently no economically viable industrial processes for reducing cadmium [Syers, 2001a]. The technical and economic conditions under which decadmiation becomes an economic option need to be established [Syers 2001b].

2.3.2 Nitric Acid

For a detailed description of the production of nitric acid please be referred to [Wiesenberger, 2001]

2.3.3 Sulphuric Acid

For a description of the production of sulphuric acid may we refer to [Wiesenberger & Kircher, 2001]

2.3.4 Ammonia

Ammonia is required for the production of various fertiliser products such as urea, ammonium-nitrate, CAN, MN-fertiliser. At many fertiliser production sites ammonia is supplied by an associated ammonia plant.

Ammonia is mainly produced by steam reforming of hydrocarbons, with natural gas being the most common feedstock. By way of these processes the feedstock is reformed with steam in a heated primary reformer and subsequently with air in a secondary reformer, in order to produce synthesis gas (N_2 , H_2), which also contains CO , CO_2 and H_2O . After removal of H_2O (condensation), CO (methanation) and CO_2 (chemical or physical absorption), the synthesis gas is compressed and synthesis of ammonia takes place on an iron catalyst.

Key environmental parameters for the production of ammonia are the amount of feedstock required, the consumption of energy for heating the primary reformer, and the existence of an efficient heat recovery system. Relevant environmental parameters are waste gas emissions from the primary reformer, such as CO_2 , NO_x and NH_3 (in case of an NO_x abatement technology), SO_2 and dust (depending on the fuel). Waste gas emissions result from the desorption of carbon dioxide (CH_4 , CO and CO_2) and from the removal of purge gases from the synthesis loop (NH_3 and CH_4). At the primary reformer, NO_x emission reduction processes can be used. With selective non-catalytic reduction (SNCR) processes, NO_x emissions below 200 mg/Nm^3 are achievable [Agrolinz 1999], [Agrolinz 2002b].

At Agrolinz Melamine GmbH, purge gas is removed from the synthesis loop between the first and second cooling step. For emission reduction, purge gas is supplied to an old modified ammonia plant, comprising of an NH_3 converter and a refrigerating plant. This ammonia plant operates as a normal NH_3 synthesis with the purge gases being the feedstock.

Process water is removed from the synthesis gas by condensation and discharged; here, an efficient wastewater treatment, such as recovery of ammonia by stripping processes, can be considered state-of-the-art technology. Wastes arise from used catalysts and hydraulic fluids.

Reference plant: In Austria, two ammonia plants are operated at Agrolinz Melamine GmbH. Table 4 presents key environmental parameter of these plants.

Table 4: Environmental parameters (2001) of the Austrian Ammonia plants [Agrolinz, 2002b].

	Plant 1	Plant 2	Limits	Comment
Production and capacity				
• Capacity [t NH ₃ /d]	1,000	520		
• NH ₃ production [t]	298.228	150.047		
• First commissioned	1974	1967		
Input				
• Input natural gas for heating [t/t NH ₃]	0.233	0.178		
• Input natural gas for process [t/t NH ₃]	0.451	0.451		
• Steam input (primary reformer) [t/t NH ₃]	1.641	1.642		
Air emissions from primary reformer				
• Waste gas volume [Nm ³ /h]	118.684	48.804		Calculated
• CO ₂ [g/Nm ³] _{dry}	200	200		Calculated
• NO _x as NO ₂ [mg/Nm ³] _{dry}	142	162	200 ^{a)}	Measured 4 times/a
• NO _x emission reduction	SNCR	SNCR		
• Reduction rate	41-52 %	19-30 %		
• NH ₃ -emissions [mg/Nm ³] _{dry}	1.1	5.1	10	Measured 4 times/a
• SO ₂ -emissions [mg/Nm ³] _{dry}	0.02	0.02	Acc. S-fuel content	Calculated
Air emissions from desorption of CO₂				
• CO ₂ desorption process	Benfield	Selexol		
• Waste gas volume [Nm ³ /h]	5,238	15,413		Calculated
• Part of CO ₂ is used for other production processes. CO ₂ emissions cf. CO ₂ balance in chapter 2.3.5				
• CO [mg/Nm ³]	125	0.4		Measured
• CH ₄ [mg/Nm ³]	72	10		Measured
Air emissions from synthesis gas loop (Purge gas)				
• NH ₃		18 kg/a		Measured 2 times/a
• CH ₄		11 t/a		Calculated
Waste water emissions				
• Process water [m ³ /h]	49	25		Measured
• Emission reduction measure	Stripping unit in 10/2002	Stripping unit in 2004		
• NH ₄ -N	0.7 kg N/t NH ₃	0.6 kg N/t NH ₃	0.1 kg N/t product ^{b)}	Measured
• CSB	0.8 kg/t NH ₃	1.0 kg/t NH ₃	50 mg/l ^{b)}	Measured
Waste				
• Spent catalysts	31 t/a	13 t/a		av. 96-01

^{a)} Limit values according to the ministerial order for furnaces (Feuerungsanlagenverordnung, Federal Law Gazette II 331/1997) will apply since 05/2003.

^{b)} Limit values according to the ordinance on the production of industrial gases (AEV technische Gase, Federal Law Gazette 670/1996) will apply at the end of 2007;

^{c)} Referring to the installed product capacity (as tons NH₃);

2.3.5 Carbon Dioxide (CO₂)

CO₂ is required for the production of urea and for the production of CAN fertilisers by conversion of calcium nitrate (ODDA process). CO₂ is usually taken from an associated ammonia production plant. Figure 4 presents the CO₂ balance at Agrolinz Melamin GmbH.

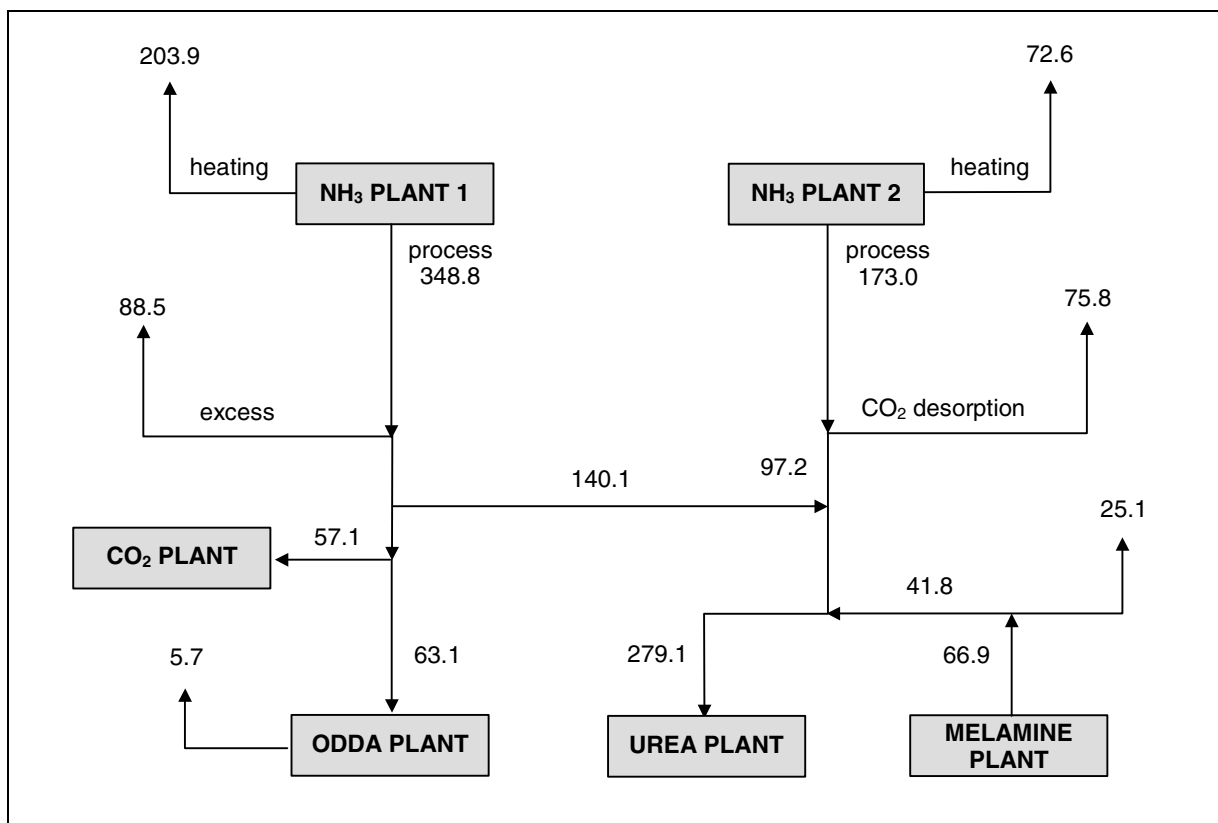

Figure 4: CO₂ balance (2001) at Agrolinz Melamin in 1,000 t CO₂/a [Agrolinz, 2002b].

2.3.6 Other Raw Materials

Apart from the raw materials mentioned before, potash salts, H₃PO₄, ammonium sulphate, ammonium phosphates (MAP and DAP), magnesium salts, dolomite, boron compounds, zinc sulphate, talcum and coating agents might be used for fertiliser production. The use of anti-foaming agents might be necessary for the phosphate rock digestion with nitric acid. As far as possible, the use of antifoaming agents, which contain dangerous substances, should be avoided.

3 SSP, TSP AND MN-FERTILISER (MIXED ACID ROUTE)

3.1 Production Processes

3.1.1 Production of Single Superphosphate (SSP)

Single superphosphate (SSP) is manufactured by treating phosphate rock with sulphuric acid. Figure 5 presents a simplified block diagram of the production of single superphosphate in a so-called den. In Austria this process is used by Donauchemie AG.

To enable the reaction with sulphuric acid, the phosphate rock is ground in a mill. The ground phosphate rock is conveyed pneumatically into a silo. The ground rock is weighed on a continuous belt weigher and fed into a mixer, where the phosphate rock is mixed with sulphuric acid (diluted from 96 % to about 75 %) at the required rate. The reaction between sulphuric acid and the fluoro-apatite contained in the phosphate rock proceeds in two stages. The insoluble phosphate rock is converted into soluble phosphate and calcium sulphate.

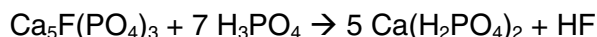
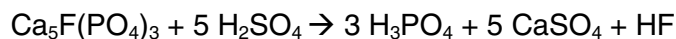

After a mixing time of 1-3 minutes, the reaction mass is discharged from the mixer onto a continuously moving enclosed conveyor, the so-called den, which has a slow moving circulating floor. The mass is held in the enclosed area for a residence time of about 20-40 minutes, thereby moving to the end of the den. The solidified mass is broken up by a cutter and transferred by an enclosed conveyor to a storage pile for "curing" at least for 1 week, in order to complete the reaction. Donauchemie AG uses single superphosphate as a main raw material for the production of MN-fertilisers (cf. chapter 3.1.3). Waste gases containing dust and considerable amounts of HF and SiF₄ arise from the digestion of phosphate rock in sulphuric acid. Waste gases are treated by wet scrubbing (cf. chapter 3.3). As a result of waste gas scrubbing, waste water emissions arise (cf. chapter 3.4). [Donauchemie 2001, 2002c].

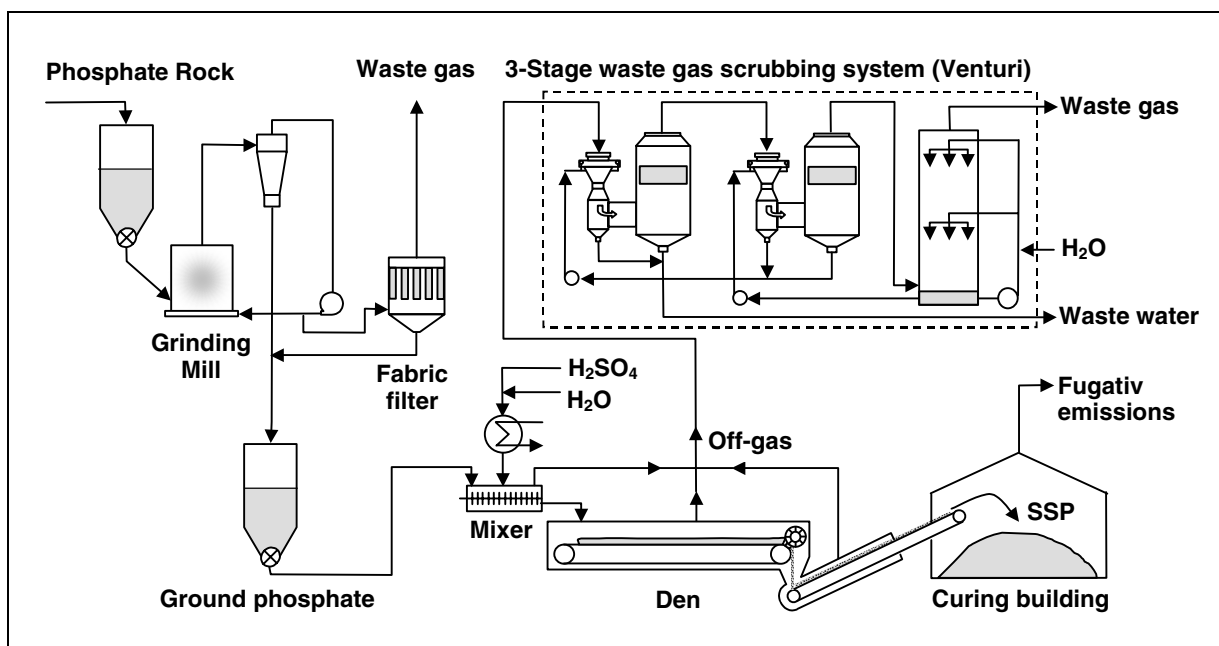
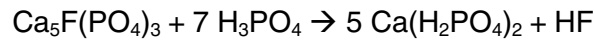

Figure 5: Schematic diagram of the production of single superphosphate in a den.

3.1.2 Production of Triple Superphosphate (TSP)

Triple superphosphate (TSP) is manufactured by treating phosphate rock with phosphoric acid.



The production of triple superphosphate in a den is similar to that for the production of single superphosphate. The same equipment is used as for single superphosphate production. However, mixing time of phosphate rock and H_3PO_4 is shorter, due to the faster chemical reaction. The heat of reaction is one-third of that for single superphosphate. The same temperature (80-100 °C) is reached, but less silicon tetrafluoride is evolved [Person, 2001]. Triple superphosphate is often used as a phosphate additive in the production of granular MN-fertilisers (cf. chapter 3.1.3). Alternatively it is sold as it is (run of pile – ROP) or granulated for sale as granulated superphosphate [Person 2001].

3.1.3 Production of Multi-Nutrient (MN) Fertilisers by the Mixed Acid Route

There are several processes for the production of multi-nutrient fertiliser using to the mixed acid route. As regards the phosphate content, starting materials might be:

- Phosphoric acid;
- Single superphosphate or triple superphosphate (digestion of phosphate rock with H_2SO_4);
- Nitrophosphoric acid (digestion of phosphate rock with HNO_3) [UBA Berlin, 2001].

Figure 6 presents a simplified schematic diagram of the production process of MN-fertiliser used by Donauchemie AG. The production process starts from single and triple superphosphate and uses a rotary granulation drum in combination with a pipe reactor.

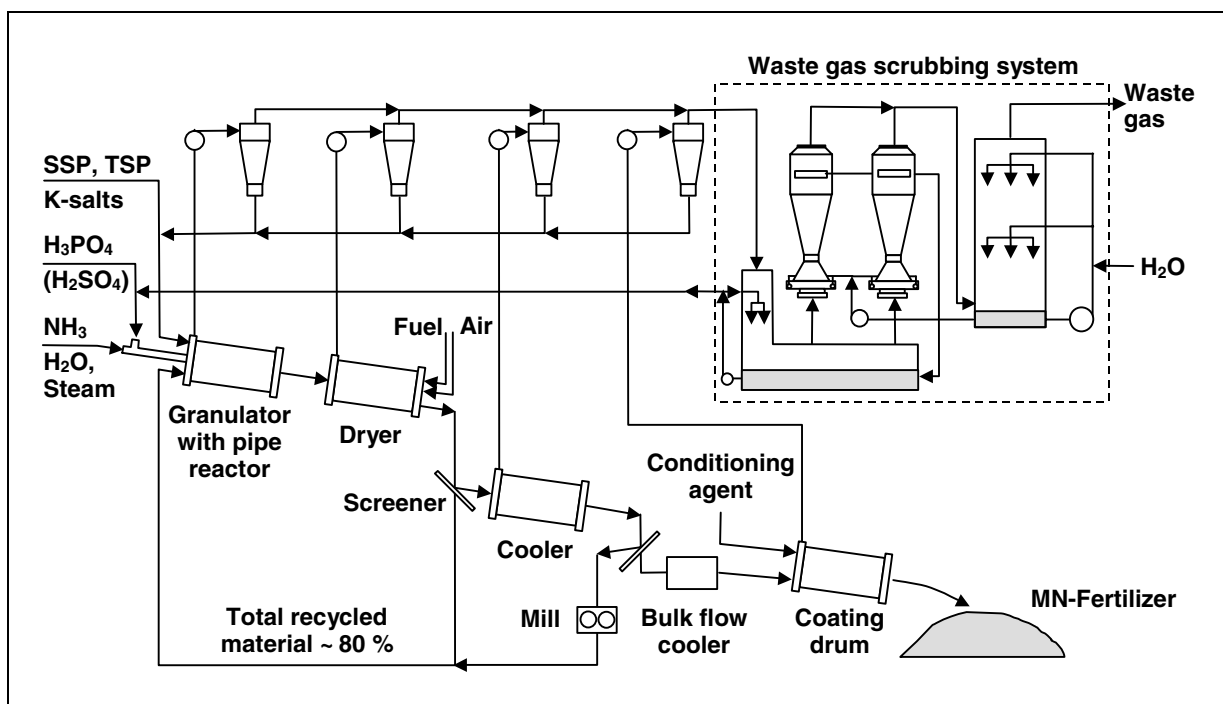

Figure 6: Schematic diagram of MN-fertiliser production (NPK and PK) in a rotary granulation drum with a pipe reactor (NPK) starting from single or triple superphosphate.

Solid starting materials (SSP/TSP and K-salts) are dosed into the rotary granulation drum. For the production of NPK fertilisers ammonia, phosphoric acid or sulphuric acid is dosed via a pipe reactor into the granulation drum. For the production of PK fertilisers, single superphosphate or triple superphosphate is granulated together with potassium salts. Crushed oversize and undersize particles are recycled into the granulation process. Scrubbing solution from waste gas treatment is also recycled into the production process. In the rotary granulation drum the mixture of recycles and raw materials is adjusted for agglomeration by injecting steam and water. The amount of steam and water required for the granulation depends on the formulation of the product and on the temperature in the granulation drum. The resulting product is dried in a drying drum. The granulate is screened and the discharged product is cooled in a cooling drum and/or in a bulk flow cooler. In order to prevent caking and dust formation, the product is usually coated with anti-caking agents.

Waste gases arising from MN production are treated by wet scrubbing (cf. chapter 3.3). Emissions of waste water can be avoided by recycling of scrubbing liquor into production (cf. chapter 3.4)

Reference plant: Donauchemie AG produces PK and NPK fertiliser starting from single and triple superphosphate. Single and triple superphosphate are alternately produced by digestion of phosphate rock in H_2SO_4 or H_3PO_4 in a Broadfield Den. MN-fertiliser are produced in a rotary granulation drum in combination with a pipe reactor. Additionally, hyperphosphate fertilisers (i.e. granulated phosphate rock for direct application) are produced.

3.2 Resources

3.2.1 Input/Output Levels

For the production of SSP (TSP) phosphate rock and H_2SO_4 (H_3PO_4) are required. For the production of single superphosphate (19 % P_2O_5) 0.66 t H_2SO_4 (100 %) per ton phosphate rock are necessary, corresponding to an input of about 0.6 t phosphate rock and about 0.4 t H_2SO_4 per ton single superphosphate produced.

For the production of compound fertilisers starting materials depend on the process and on the formulation of the products. If the first stage is the production of superphosphate, main raw materials are SSP/TSP, H_3PO_4 , KCl and K-salts, Ammoniumsulphate, Monoammoniumphosphate (MAP), and Mg-salts. Table 5 presents raw materials for the production of SSP, TSP and MN-fertiliser (mixed acid route) at Donauchemie. Table 6 presents the production of fertilisers at Donauchemie AG. As stated above, the data presented only give an example.

Table 5: Main starting materials for the production of SSP, TSP and MN-fertilisers by the mixed acid route [Donauchemie, 2001].

Raw material	Total Input ^{a)}	Raw material	Total Input ^{a)}
Phosphate rock	110,000 t ^{b)}	Kieserite	2,100 t
NH ₃	5,300 t	K ₂ SO ₄	6,700 t
H ₂ SO ₄	50,000 t	Ammoniumsulphate	25,000 t
H ₃ PO ₄	25,000 t	MAP	5,000 t
KCl	48,000 t	MgCl ₂	1,200 t

^{a)} for the production of SSP, TSP, MN-fertiliser

^{b)} incl. the production of and Hyperphosphate fertilisers (phosphate rock for direct application)

Table 6: Fertiliser production of Donauchemie [Donauchemie, 2001], [Donauchemie 2002a].

Fertiliser	Main compositions	Production (2000)	Capacity
NPK fertiliser (mixed acid route)	6/10/16 + 11S 12/10/15 + 14S 12/5/15 + 18S 6/8/20 + 2MgO + 15S	106,000 t	500 t/d
PK-fertiliser (mixed acid route)	12/20 + 8 S 0/10/30 + 3MgO + 11S	52,000 t	1,000 t/d
Single superphosphate (SSP) ^{a)}	19 % P ₂ O ₅ + 12% S	50,000 t	700 t/d
Triple superphosphate (TSP) ^{a)}	45 % P ₂ O ₅ + 2.5% S	5,600 t	500 t/d
Hyperphosphate Fertilisers ^{b)}	P (26 % P ₂ O ₅ and 29 % P ₂ O ₅) PK (0/18/18 and 0/22/10)	50,000 t	300 t/d

^{a)} SSP and TSP are mainly used for the PK and NPK fertiliser production

^{b)} Granulated phosphate rock for direct application

3.2.2 Energy

As regards the production of **superphosphates (SSP and TSP)**, energy is mainly required for grinding of the phosphate rock and for the waste gas scrubbing system. Energy for the grinding mill depends on the type of the phosphate rock and is in the order of about 15-18 kWh per ton phosphate rock. Due to a high pressure drop of the Venturi scrubbers energy input corresponding to about 20 kWh/t product is required for waste gas scrubbing. Power consumption for scrubbing the waste gas of the phosphate rock digestion is about 200 kW and for scrubbing the waste gas of the granulation is about 350 kW [Donauchemie 2001, 2002c].

Specific energy consumption for the production of **MN-fertiliser (NPK and PK)** by the mixed acid route starting from SSP and TSP is presented in Table 7.

Table 7: Specific energy consumption for the production of MN-fertilisers [Donauchemie 2001, 2002c].

Energy carrier	Specific energy demand per ton product	
	NPK-fertiliser	PK-fertiliser
Natural gas (dryer)	8 Nm ³ (80,7 kWh)	10 Nm ³ (100,8 kWh)
Electric energy (van)	34 kWh	28 kWh
Steam (granulation)	0.080 t	0.060 t

3.2.3 Water Demand

The production of superphosphate (SSP or TSP) and MN-fertiliser requires water for the dilution of sulphuric and/or phosphate acid, for granulation operations and for waste gas scrubbing.

According to [Donauchemie 2001], total water consumption for the production of SSP or TSP is about 1.2 m³/t product. About 20 m³/h water are required for waste gas scrubbing corresponding to a specific water consumption of 0.8 m³/t product.

Production of MN-fertiliser (mixed acid route) requires water for the granulation step and the scrubbing of the waste gas. According to [Donauchemie 2001], specific water input for MN-production is about 1.4 m³/t NPK fertiliser and 0.9 m³/t PK fertiliser.

3.3 Emissions to Air and Waste Gas Treatment

3.3.1 Main Pollutants and Emission Sources

Single and triple superphosphate

Dust emissions arise from grinding of the phosphate rock. Emissions of dust, HF and SiF₄ arise from the digestion of phosphate rock in sulphuric or phosphate acid. SiF₄ is formed by the reaction of HF with SiO₂.



Phosphate rock contains 2-5 % fluorine. 10-30 % of fluorine is rapidly evolved as silicon tetrafluoride during acidulation with H₂SO₄ [Person, 2001]. The production of triple superphosphate (acidulation with H₃PO₄) evolves less silicon tetrafluoride than at the production of single superphosphate [Donauchemie 2001].

Multi-nutrient fertilisers (mixed acid route)

Main pollutants from the production of MN-fertilisers by the mixed acid route are dust, NH₃ and HF. When PK-fertilisers are produced, HCl is released from chloride salts during granulation or drying operations. There are several emission sources from the production process: Off gases are released from the rotary granulation drum and the pipe reactor (in particular NH₃ and dust) and from the following operations: drying, cooling, screening and crushing.

3.3.2 Waste Gas Treatment

Single and triple superphosphate

Waste gases arising from the grinding of phosphate rock are treated by fabric filters. Emissions below 5 mg/Nm³ are achievable by this measure.

Waste gases arising from the den, the cutter housing and the enclosed conveyor are combined and treated together. The off-gases are supplied to a scrubber, in which the silicon tetrafluoride reacts with water, forming fluosilicic acid and SiO₂:

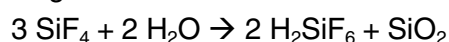

The scrubbing liquid is dilute, circulating fluosilicic acid. The first cleaning units of the waste gas scrubber usually consist of Venturi scrubbers, because SiO₂ forming during scrubbing is colloidal and tends to solidify in an uncontrollable fashion. In order to achieve high scrubbing efficiencies, usually three units are placed in line. Dust can be eliminated first, if necessary, in a special scrubber. [Person, 2001], [Denzinger et al. 1979]. With regard to the HF emissions, removal efficiencies of more than 99% are achievable [Donauchemie 2001].

Production of MN-fertiliser by the mixed acid route

Off-gases are collected from the rotary granulation drum and the pipe reactor, from drying, cooling, coating and screening and crushing operations. The off-gases are de-dusted, combined and treated together by wet scrubbing. Dust emissions of 50 mg/Nm³ are reported [EFMA 1995] and emissions below 50 mg/Nm³ are stipulated by [TA Luft 2000]. Separated dust is recycled into the production process. Water and optionally acidic or alkaline effluent from periodically cleaning the plant can be used for scrubbing liquor ¹²⁾.

¹²⁾ Acidic or alkaline conditions of the scrubbing liquor depend on the production. The production of PK fertilizers evolve acidic emissions (HCl), the production of NPK fertilisers alkaline emissions (NH₃).

3.3.3 Reference Plant – Donauchemie GmbH

Table 8 presents emissions to air from the production of single and triple superphosphate and multi-nutrient fertilisers at the Austrian reference plant Donauchemie AG. The indicated off-gas concentrations are values averaged over the quarterly measurements of the last two years. According to [Donauchemie 2002d] the indicated off-gas concentrations are representative for half-hour mean values. Current emission limits are apply according to the TA Luft 1986, i.e. for dust emissions 75 mg/Nm³, for HCl emissions 30 mg/Nm³ and for HF emissions 5 mg/Nm³ [Donauchemie 2001].

Table 8: Emissions into air from SSP, TSP and MN-fertiliser production (mixed acid route) [Donauchemie 2001, 2002c, 2002d].

Emission source	Waste gas treatment	Pollutant	Emissions levels		
			Emission value [mg/Nm ³] ^{a)}	Load [kg/h] ^{b)}	Emission factor [g/t product] ^{b)}
Grinding mill	Fabric filter	Dust	4.2	–	–
Production of single superphosphate or triple superphosphate (waste gas volume: 25.000 Nm ³ /h)	3 stage waste gas scrubber	F (as HF)	4.9	0.12	6
		Dust	46	1.15	58
		HCl	26	0.65	33
Production of MN-fertiliser (NPK and PK-fertiliser) in a rotary granulation drum with pipe reactor incl. drying, cooling and screening operations (waste gas volume 160.000 Nm ³ /h)	Cyclones, 3 stage waste gas scrubber	NH ₃ ^{c)}	4.6	0.74	37
		F (as HF)	3.2	0.51	26
		Dust	70	11.20	560
		HCl ^{d)}	23	3.70	184
Hyperphosphate fertiliser - Granulation of ground soft phosphate rock for direct application	–	Dust	15	0.60	40
		HF	2.1	0.08	6
		HCl ^{d)}	3.2	0.13	8

^{a)} Measurements quarterly

^{b)} Calculation

^{c)} arising from the production of NPK fertilisers

^{d)} arising from the production of PK fertilisers

Single and triple superphosphate

The grinding mill for disintegration of phosphate rock is equipped with a fabric filter. In order to reduce air emissions from digestion of phosphate rock with sulphuric or phosphate acid a three stage scrubbing system is used. The first and second stages are Venturi scrubbers, the third stage is a conventional scrubber (also cf. Figure 5).

Multi-nutrient fertilisers (mixed acid route)

Off-gases from granulation and the pipe reactor and from the drying, screening, cooling and coating operations are collected, de-dusted with cyclones, combined and treated together. The waste gas is scrubbed in a 3 stage scrubbing system consisting of the following steps (also cf. Figure 6). For scrubbing, fresh water and effluent from periodical cleaning of the plant is used.

- A first stage for pre-moistening of the waste gas,
- two parallel Venturi scrubbers and
- a conventional scrubber.

3.4 Waste Water Emissions and Waste Water Treatment

3.4.1 Main Pollutants and Emission Sources

Single and triple superphosphate

Main emission source at the production of single and triple superphosphate is scrubbing liquor arising from waste gas scrubbing. Scrubbing liquor is contaminated with phosphates, fluorine compounds (in particular H_2SiF_6), sulphates, heavy metals, such as Cd and Hg, and As. In particular the discharge of highly toxic fluosilicic acid, which arises in considerable amounts, is a major environmental issue of the phosphate fertiliser manufacture.

Multi-nutrient fertilisers (mixed acid route)

Waste water emissions from the production of MN-fertiliser (mixed acid route) can totally be avoided when scrubbing solutions arising from waste gas scrubbing are recycled into the fertiliser production process. Some effluent might be generated from cleaning of the installations. Waste water emissions can also be avoided when these effluents are used for waste gas scrubbing (cf. chapter 3.4.3).

3.4.2 Waste Water Treatment and Measures for Reduction of Waste Water Emissions

Single and triple superphosphate

Scrubbing solutions arising from waste gas scrubbing contain considerable amounts of fluosilicic acid (H_2SiF_6) and are contaminated by several pollutants, such as heavy metals. Recycling or recovery of H_2SiF_6 has been extensively discussed in literature and reviewed by [Smith 1999].

Several processes for the recovery of fluosilicic acid from the waste water of phosphoric fertiliser industry have been reported. However, the main problem is that fluosilicic acid has only limited applications for direct use. H_2SiF_6 has been considered to be suitable as a raw material for the production of aluminium fluoride [Kongshaug et al., 2001]. However, [Smith 1999] indicates that the P_2O_5 content of the produced acid is above the tolerance for use in the manufacture of AlF_3 . According to [Di Lena et al., 2000] the use of H_2SiF_6 as a raw material for the aluminium industry has been abandoned, due to minor quality of the resulting product. For recovery of fluosilicic acid they propose a process which has already been applied for several years for the neutralisation of water contaminated with fluorine compounds. This process result in the production of a mixture of silica and precipitated calcium fluoride. The product has already been successfully sold to the cement industry. After some modifications, this process might also be used in phosphate fertiliser manufacture plants.

In the U.S., fluosilicic acid arising from scrubbing liquor of the phosphate fertiliser industry is used for fluoridation of drinking water. In almost all European states, fluoridation of drinking water is not allowed or has been banned due to ethical and/or medical considerations [FAN 2002]. Scrubbing liquor of phosphate fertiliser is contaminated with several toxic pollutants, thus the use of scrubbing liquor for fluoridation of drinking water is not an adequate method of disposal. The use of fluosilicic acid from scrubbing solutions of the phosphate fertiliser industry for fluoridation of drinking water has to be considered as Non-BAT.

For the recycling of fluosilicic acid to the superphosphate den, [Smith 1998] in particular refers to several plants in New Zealand operating total recycle processes for waste gas scrubbing. He indicates that recycling of H_2SiF_6 into the production process might result in an increased load on the scrubbing system.

Currently, at the Austrian reference plant waste water is neutralised and discharged. A project has been started in 2001 aiming at the reduction of fluorine discharge into water [Donau-chemie 2001] (cf. chapter 3.4.3).

Multi-nutrient fertilisers (mixed acid route)

Waste water emissions from the MN-fertiliser production can be avoided when scrubbing solutions from waste gas scrubbing are recycled into the fertiliser production process. Washing solutions from cleaning the fertiliser plant can be used for waste gas scrubbing, if the plant is operated alternately under acidic and alkaline conditions (cf. reference plant described in chapter 3.4.3).

3.4.3 Reference Plant – Donauchemie GmbH

Production of single and triple superphosphate

From the production of SSP and TSP about 5-10 m³/h scrubbing liquor arise, which actually is discharged into running waters. Waste water emissions are presented in Table 9.

The emissions of fluorine compounds are expected to exceed emission limits according to the ordinance on the limitation of wastewater emissions from the production of inorganic fertilisers "AEV Düngemittel", which will apply for existing plants at the end of 2002 (cf. chapter 8.1.4). Donauchemie AG has started a project aiming at a reduction of H₂SiF₆ emissions into water [Donauchemie, 2001]. Within this project in particular the precipitation of fluorine compounds as CaF₂ by adding lime and subsequent neutralisation of the waste water has been taken into considerations. According to [Donauchemie, 2002] the project will be realised until the end of 2002.

Table 9: Waste water emissions arising from the production of P-fertilisers at the Austrian plant current emission limits and emission limits according to the ministerial order for the limitation of wastewater emissions from the production of inorganic fertilisers [Donauchemie 2001], [Donauchemie 2002a], [AEV Düngemittel 1996].

Pollutant	Waste water emission levels ^{a)}	Current emission limits ^{b)}	AEV Düngemittel ^{c)}
Waste water volume	5-10 m ³ /h	n.a.	-
Temperature	29°C	30°C	30 °C
pH	6.0-7.5	6.0-8.5	6.5-8.5
Filterable substances	0.36 kg/t P ₂ O ₅	50 kg/t P ₂ O ₅	50 kg/t P ^{e)}
Total P	0.59 kg/t P ₂ O ₅	0.6 kg/t P ₂ O ₅	0.6 kg/t P ^{e)}
Ammonium as N	1.7 kg/t P ₂ O ₅	2.0 kg/t P ₂ O ₅	2.0 kg/t P ^{e)}
Fluorine compounds as F	1.17 kg/t P ₂ O ₅	3.0 kg/t P ₂ O ₅	3.0 kg/t P ^{e)}
Cd	< 0.01 g/t P ₂ O ₅	0.1 g/t P ₂ O ₅	0.1 g/t P ^{e)}
Hg	< 0.01 g/t P ₂ O ₅	0.02 g/t P ₂ O ₅	0.02 g/t P ^{e)}
Zn	n.a.	n.a.	2 g/t P ^{e)}
CSB	0.6 kg/t P ₂ O ₅	0.6 kg/t P ₂ O ₅	0.6 kg/t P ^{e)}

^{a)} pH, fluorine compounds, temperature, filterable substances are measured daily, other substances are measured quarterly.

^{b)} Emission limits according to the current permit; according to [Donauchemie 2001] the permit is expected to be revised, as the "AEV Düngemittel" will apply since the end of 2002 (also cf. footnote c and chapter 8.1.4)

^{c)} Emission limits for the discharge of wastewater into running waters according to the ministerial order "AEV anorganische Düngemittel", which will apply since the end of 2002. For further details, such as monitoring and sampling requirements, please be referred to chapter 8.1.4.

^{d)} Waste water arising from the scrubber treating the off-gas of the raw phosphate digestion.

^{e)} Emission limits refer to the installed product capacity (as tons P of the product).

Multi-nutrient fertilisers (mixed acid route)

At Donauchemie AG, waste water emissions do not arise from the MN-fertiliser granulation plant. Scrubbing liquor from waste gas scrubber is recycled into the production process.

Usually, no waste water emissions arise from cleaning the granulation plant. As far as possible, the granulation plant is operated alternatingly under acidic (PK-fertiliser) and alkaline conditions (NPK-fertiliser). Effluent generated from periodically cleaning the plant with water is collected in a reservoir and used for waste gas scrubbing within the next production period. Waste water is only released if the same fertiliser type is produced within two following production periods [Donauchemie 2001].

3.5 Wastes and Residues

No waste and residues arise from the Austrian plants for the production of superphosphate and MN-fertiliser by the mixed acid route.

4 FERTILISER PRODUCTION BY THE NITROPHOSPHATE ROUTE

4.1 Processes for the Production of MN-fertilisers and Conversion of Calcium Nitrate Tetrahydrate (CNTH)

As to the production of NPK by the nitrophosphate route (ODDA process), various processes are described in literature, for which we refer to [Kongshaug et al., 2000].

Figure 7 schematically presents the MN-fertiliser production process according to the nitrophosphate route (ODDA process), which is used by Agrolinz Melamin GmbH.

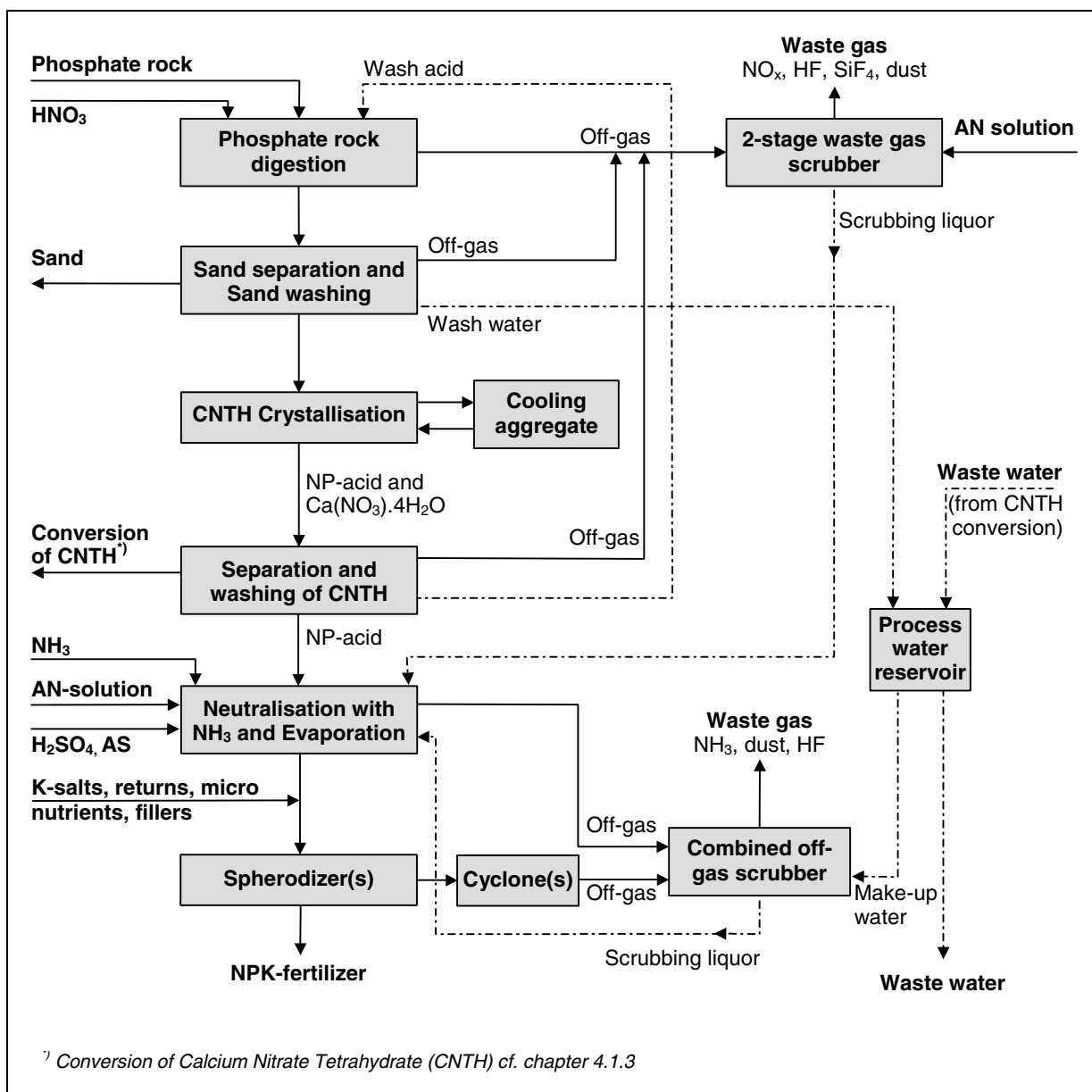

Figure 7: Block diagram of the NPK fertiliser production by the nitrophosphate route [Agrolinz 2001].

Main steps of the ODDA process are:

- Digestion of phosphate rock with nitric acid;
- Crystallisation and separation of calcium nitrate tetrahydrate (CNTH) from nitrophosphoric acid (NP-acid);
- Ammoniation i.e. neutralisation of nitrophosphoric acid (adjustment of N/P ratio);
- Granulation of the slurry and coating of the product;
- Conversion of calcium nitrate tetrahydrate into ammonium nitrate and lime and production of CAN fertilisers (cf. chapter 5).

Reference plant: Agrolinz Melamin GmbH produces MN-fertiliser using the nitrophosphate route (ODDA process). Calcium ammonium nitrate (CAN) fertilisers are produced starting from both the conversion of CNTH, which is a by-product of the ODDA process, and the synthesis of AN by neutralisation of HNO_3 and NH_3 .

4.1.1 Digestion of Phosphate Rock

Phosphate rock is dissolved in an excess of weak nitric acid (< 60 % HNO_3) using a cascade reactor. The reaction takes place at a temperature of about 70 °C and is maintained by the reaction heat. The overall reaction can be represented by the following chemical equation:

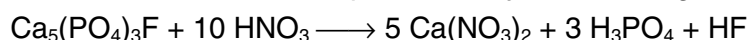

Dissolution of phosphate rock in HNO_3 causes the formation of HF and SiF_4 . Nitrogen oxides are formed by the reduction of HNO_3 . The NO_x formation is in particular favoured by a high content of organic substances and ferrous salts. The digestion reaction is governed by three interrelated factors: temperature, particle size, and residence time in the reactor. If the temperature is too low and the particles are too large, a longer residence time will be necessary. If the temperature is too high, excessive formation of NO_x will take place. Antifoaming agents are added in order to prevent foaming. Acid-insoluble material mostly consists of quartz sand and is separated with lamella separators and belt filters. The filtered sand is washed and dried. It either can be used in the construction industry or is disposed. Waste gas is collected, combined and treated together from the following operations: digestion of phosphate rock, separation and washing of sand and filtration and washing of calcium nitrate. [Conradson 2001], [Laue et al. 2001], [Agrolinz 2001].

4.1.2 Crystallisation and Filtration of Calcium Nitrate Tetrahydrate (CNTH)

$\text{Ca}(\text{NO}_3)_2$ formed by the digestion of phosphate rock is removed from the solution, in order to guarantee the production of plant-available P_2O_5 and in order to increase the nutrient content of the MN-fertiliser. $\text{Ca}(\text{NO}_3)_2$ precipitated as calcium nitrate tetrahydrate (CNTH) is obtained by cooling to temperatures of about 0°C. CNTH crystals are separated with belt filters. Separated CNTH crystals are washed with cold nitric acid and a solution of ammonium nitrate, in order to recover the adherent dissolving solution on the crystals and to minimise the residual P_2O_5 content. The washing acid can be totally recycled to the rock phosphate digestors. The remaining nitrophosphoric acid (NP-acid) is further processed into MN-fertiliser. [Agrolinz 2001], [Conradson 2001], [Laue et al., 2001], [Pawta & Shamsi, 1998].

4.1.3 Conversion of Calcium Nitrate Tetrahydrate (CNTH)

The production of nitrophosphate fertilisers by digestion of phosphate rock with nitric acid in the ODDA process produces as a by-product calcium nitrate tetra hydrate (CNTH). The conversion of CNTH with NH_3 and CO_2 results in the production of AN and lime, which can be used for the production of CAN (cf. chapter 5.1.2).

NH_3 and CO_2 are dissolved in a NH_4NO_3 solution, which is circulating in a carbonising column. CO_2 reacts with gaseous NH_3 forming ammonium carbonate $(\text{NH}_4)_2\text{CO}_3$. The heat of reaction is removed by cooling.

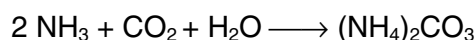

The calcium nitrate tetrahydrate CNTH is also dissolved in an NH_4NO_3 solution. The two solutions are then reacted.

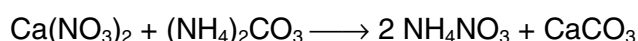

After the reaction, the approx. 65 % NH_4NO_3 solution is separated from CaCO_3 and concentrated in a two stage evaporator. The AN solution can be used for the production of calcium ammonium nitrate fertiliser (cf. chapter 5.1.2). The separated CaCO_3 still contains small amounts of ammonium compounds and phosphate and is only used for the CAN production.

4.1.4 Neutralisation/Evaporation of the Nitrophosphoric Acid

The NP-acid containing H_3PO_4 , HNO_3 , some HF, dissolved Ca- and Mg-nitrates, dissolved impurities (e.g., Fe, Al, Si), and suspended insoluble particles (e.g. quartz sand) is neutralised with ammonia under strict pH control. Due to the exothermic reaction the temperature increases to about 110-120°C. Ammonium nitrate solution and sulphuric acid is added to adjust the N/P₂O₅ ratio in the final product. The slurry is evaporated, if necessary, to adjust the water content for granulation. Due to the heat of the reaction water, ammonia and HF are evolved during the neutralisation/evaporation operations. Waste gases are treated by wet scrubbing. Process effluents might arise when the exhaust vapours are (partly) condensed before or during waste gas treatment (cf. chapter 4.4). After addition of potassium, the melt is ready for granulation, drying and finishing. [Meyer & Nitzschmann, 1998], [Conradson 2001].

4.1.5 Spherodizer Granulation

Granulation of a slurry produced by the nitrophosphate route often proceeds in a Spherodizer, as this process is very efficient for slurry granulation. The Spherodizer process combines granulation and drying in a single process step. The Spherodizer is an inclined rotary drum consisting of two zones, the granulation zone and the drying zone. Recycled material consisting of undersize and crushed oversize particles (granulation loop) is fed into the granulation zone. The recycled particles generate a moving bed in the drum, into which the slurry containing 10-20 % water is sprayed. Air is preheated with gas burners up to 400 °C and flows co-currently in the spherodizer evaporating the water from the NP liquor and building up dry granules with a water content of <1.5%. A part of the granulation air can be taken from warm off-gas of the following cooling drum and the off-gas from de-dusting processes (conveyors and elevators). Waste gas from the Spherodizer drum is de-dusted with cyclones and treated by wet scrubbing. The product is cooled in drum coolers and/or bulk flow coolers and treated with anti-caking agents. [Agrolinz 2001], [Conradson 2001].

4.2 Resources

4.2.1 Raw Material Input for the Nitrophosphate Route

Input/output of the production of compound fertilisers by the nitrophosphate route mainly depend on the nutrient content of the final products and the composition of the raw materials. Main starting materials for the nitrophosphate route are phosphate rock, HNO_3 , NH_3 , AN melt, and – for the production of NPK fertilisers – potash salts.

The overall nutrient content and the N:P₂O₅-ratio of the final NP(K) product determine the minimum amount of calcium, which has to be removed as calcium nitrate by crystallisation. Different NP grades result in different amounts of AN and lime. Also, if CAN is produced, the quantity of excess lime changes with the NP grade. An additional installation of a AN synthesis allows the complete use of all lime for CAN production and the production of MN-fertilisers with high N-contents. Figure 8 shows an example of a mass balance for the production of NP 20-20 and CAN with an additional AN production [Meyer & Nitzschmann, 1998].

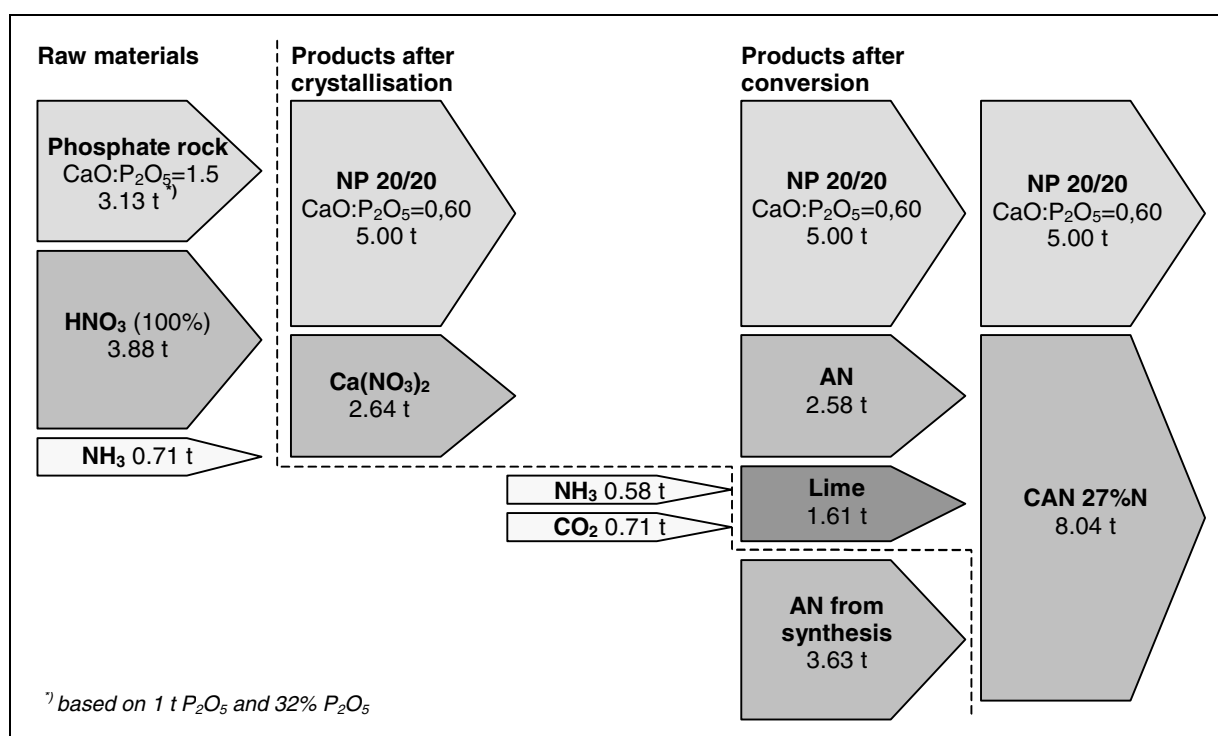

Figure 8: Example of a mass balance for the production of NP 20-20 and CAN with extra AN production referring to 1 t P₂O₅ [Meyer & Nitzschmann 1998].

Multi-nutrient fertilisers

Table 10 presents starting materials for the production of MN-fertiliser (nitrophosphate route) at Agrolinz Melamine GmbH. Input values depend on the product compositions, therefore the given values can only present an example.

Table 11 presents the output of fertiliser production at Agrolinz Melamine GmbH.

Table 10: Input for the production MN-fertilisers (ODDA process) without input for the conversion of CNTH [Agrolinz 2002c].

Starting material	Input (2001) for NPK (ODDA process) and CNTH conversion	Starting material	Input (2001) for NPK (ODDA process) and CNTH conversion
Phosphate rock	143,433 t/a	Dolomite	2,300 t/a
NH ₃	38,600 t/a	Ulexite (B-comp.)	178 t/a
HNO ₃	91,350 t/a	Zincsulphate	7 t/a
H ₂ SO ₄	35.000 t/a	Talcum	430 t/a
KCl	64,200 t/a	Coating agents	390 t/a
Kieserite	11,500 t/a	Defoaming agents	25 t/a
K ₂ SO ₄	4,200 t/a		

Table 11: Output (MN-fertilisers and by-product Ca(NO₃)₂) of the ODDA process [Agrolinz 2001, 2002a].

Output	Main compositions	Production (2000)	Capacity [t/d]
MN-fertiliser (NPK and NP)	20/8/8 + 3% MgO + 4% S; 15/10/10 + 4% MgO + 6% S; 15/15/15 + 3 S; 13/13/21+ 2% S; 14/10/20 + 5% S; 12/12/17 + 2% MgO + 7% S; 18/28/0	325,000 t	1,200 t/d

^{a)} calculation referring to 100 % AN

Conversion of CNTH

For the production of AN solution by CNTH conversion 1.728 t Ca(NO₃)₂·4H₂O per ton AN (100 %), 0.392 t CO₂/t AN (100%) and 0.213 t NH₃/t AN (100 %) are required [Agrolinz 2002c].

4.2.2 Energy and Cooling Water Demand

Table 12 presents the specific energy demand for the production of MN-fertilisers (NP and NPK) by the nitrophosphate route. About 17 m³ cooling water per ton product is required for the production of MN-fertilisers [Agrolinz Melamin, 2001].

Table 12: Specific energy demand for the production of MN-fertilisers (NP and NPK) by the nitrophosphate route [Agrolinz Melamin, 2001]

(Energy carrier) Fuel	Specific energy demand per ton product
Natural gas	23 Nm ³
Electricity	109 kWh
Steam	0.17 t
Compressed air	38 Nm ³

4.3 Emissions to Air and Waste Gas Treatment

4.3.1 Main Pollutants and Emission Sources

The main pollutants arising from MN-fertiliser production by the nitrophosphate route are dust, NO_x , NH_3 and fluorine compounds. The following processes contribute to emissions to air:

- Digestion of phosphate rock including separation/washing of sand and filtration/washing of calcium nitrate tetrahydrate (CNTH),
- Conversion of CNTH
- Neutralisation/evaporation of NP-acid, and
- Slurry granulation.

Emission sources of NO_x and fluorine compounds are the digestion of phosphate rock, the separation of sand and the filtration of CNTH. NO_x is formed by redox reactions of HNO_3 with organic substances and/or ferrous salts. From the neutralisation/evaporation unit, emissions of NH_3 and fluorine compounds are released. Dust, NH_3 and fluorine compounds are released from slurry granulation.

4.3.2 Waste Gas Treatment

Digestion of phosphate rock

Emissions of NO_x and fluorine compounds are collected from following sources: phosphate rock digestion, separation/washing of sand and filtration/washing of CNTH. In order to reduce these emissions off-gases are combined and treated together by wet scrubbing. AN solution is used as scrubbing liquor. Figure 9 presents a block diagram of multi-stage NO_x waste gas scrubbing of the rock phosphate digestion at the ODDA process.

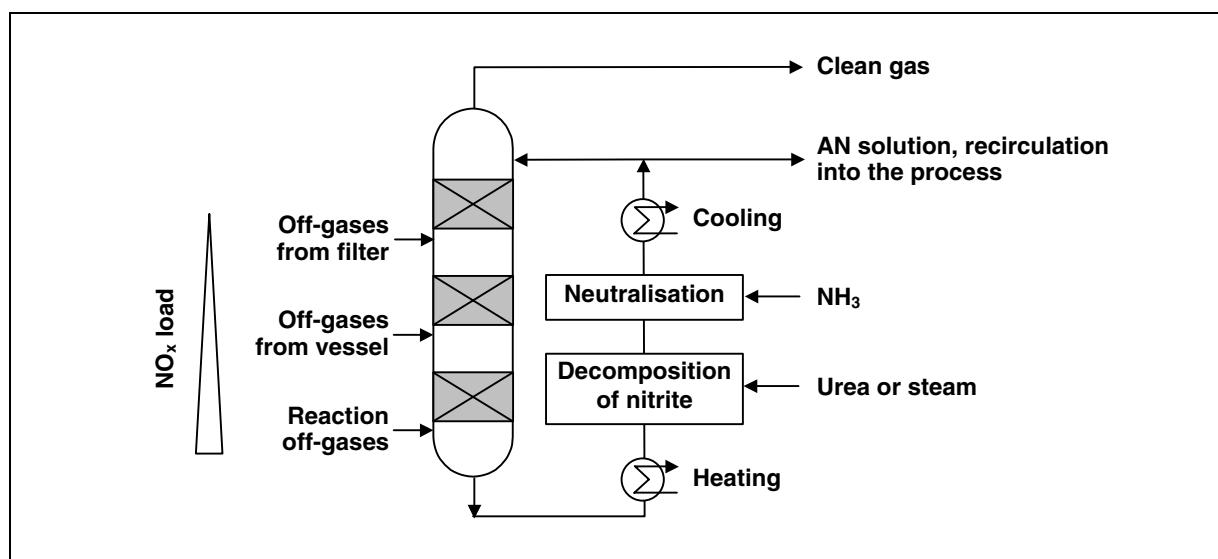

Figure 9: Multi-stage NO_x waste gas scrubbing with AN solution of the phosphate rock digestion (ODDA process) and regeneration of the scrubbing solution [Wunder 1990].

Additionally to scrubbing, NO_x emissions can be reduced when using phosphate rock with low contents of organic substances and ferrous salts. Digestion temperature has to be controlled accurately. If the digestion temperature is too high, excessive formation of NO_x will take place.

NP neutralisation/evaporation unit

In order to reduce emissions of NH_3 and F compounds, exhaust vapours from the NP neutralisation/evaporation unit are treated by wet scrubbing. If the vapours are partly condensed and the off gases are subsequently treated by a detached NH_3 scrubber, considerable amounts of waste water will arise as a cross media effect. This cross media effect will be avoided if the exhaust vapours from the neutralisation/evaporation unit are treated together with the off-gases of the granulation process (see chapters 4.3.3, 4.4.3 and below)

Granulation unit

Waste gas from the Spherodizer process is de-dusted with cyclones and then treated by wet scrubbing. If the off-gas is treated with a detached scrubber, such as an Venturi scrubber, cross-media effects will occur, as considerable amounts of scrubbing liquor will arise. By combining scrubbing of granulation off-gases together with neutralisation/evaporation exhaust vapours, cross-media effects can be avoided (cf. chapters 4.3.3, 4.4.3 and below).

Combined scrubbing of neutralisation/evaporation and granulation off-gases: Instead of condensing the exhaust vapours from the NP neutralisation/evaporation unit, they are introduced as they are in a scrubber, which at the same time cleans the off-gases of the Spherodizer(s). The hot off-gases of the Spherodizer ($\sim 100\text{ }^\circ\text{C}$) are not saturated with H_2O and the heat content is used to evaporate additional water in the scrubber. Thus, the combined scrubber works as an evaporator for liquid effluents without additional energy requirement. Concentrated scrubbing liquor can be recycled into the production process. This way avoids liquid effluents from both neutralisation/evaporation and granulation units. At the same time the main part of the nutrients normally lost in liquid effluents are recovered [Meyer & Nitzschmann, 1998].

Conversion of CNTH

Waste gases arising from the separation and washing of the CNTH crystals are treated together with waste gases from the digestion of phosphate rock. Other waste gases such as exhaust vapours arising from evaporation of the AN solution can be treated together with the waste gases arising from a subsequent CAN production process (cf. chapter 5.3.2).

4.3.3 Reference Plant – Agrolinz Melamin GmbH

Table 13 presents emission levels of the major air emission sources of the production of MN fertilisers at Agrolinz Melamin GmbH [Agrolinz 2002c], [Agrolinz 2002e].

Digestion of Phosphate Rock

Waste gases from the phosphate rock digestion are scrubbed in a two stage scrubber. The waste gas volume is about $25,000\text{ Nm}^3/\text{h}$. Scrubbing liquor is totally recycled into the production process. Table 13 presents emission levels and emission limits.

Conversion of calcium nitrate tetra hydrate (CNTH)

Waste gases arising from the separation of CNTH treated together with waste gases of the digestion of phosphate rock, from conversion with waste gases from the CAN production. For figures, the reader is referred to Table 13 and to chapter 5.3.3, Table 21.

Table 13: Emission levels of the major air emission sources of the MN fertiliser production at Agrolinz Melamine GmbH [Agrolinz 2002c], [Agrolinz 2002e], [Magistrat Linz 2002a].

Emission source	Pollutant	Emission levels			Permit/ Emission limits according to state-of-the-art ^{k)} [mg/Nm ³]
		Emission value 2001 (2000) [mg/Nm ³] ^{a)}	Annual load 2001 (2000) [t/a]	Emission factor [g/t product]	
Digestion of phosphate rock (waste gas volume 25,000 Nm ³ /h)	NO _x as NO ₂	206.5 ^{b)} (245.2) ^{b)}	47.3 (51.4)	145 ^{h)}	< 400 ^{k)}
	HF	0.34 ^{b)} (0.30) ^{b)}	0.08 (0.06)	0.24 ^{h)}	< 2 ^{k)}
Combined waste gas scrubbing of neutralisation/evaporation and granulation units (waste gas volume 250,000 Nm ³ /h) ^{c)}	Dust	26.6 ^{d)}	6.7 kg/h ^{g)}	133 ^{j)}	25 ^{l)}
	NH ₃	7.37 ^{d)}	1.9 kg/h ^{g)}	38 ^{j)}	30 ^{l)}
	NO _x as NO ₂	22.4 ^{e)}	5.6 kg/h ^{g)}	112 ^{j)}	30 ^{l)}
	HF	1.65 ^{e)}	0.4 kg/h ^{g)}	8.0 ^{j)}	2 ^{l)}
Other emission sources	Dust	^{f)}	1.50 (0.37)	-	< 20 ^{k)}

a) Emission values are taken from the annual emission report 2001 (2000). Indicated emission values are averages on measured half-hour mean values.

b) Measurements quarterly

c) Trial operation since 09/2001 (for 2 years); When comparing with other waste gas scrubbers waste water emissions have to be considered, too.

d) Measurements twice a month.

e) Measurements quarterly.

f) Various single emission sources with measurements

g) The scrubber is in operation since 09/2001. Therefore the annual emissions of 2001 are not representative for the operation of the scrubber

h) Calculation referring to an annual production of 325,000 t MN fertiliser/a

j) Calculation referring to the daily production capacity of 1,200 t MN fertiliser/d

k) The indicated emission values mostly represent emission limit values of the installations at Agrolinz Melamine GmbH. In case of state-of-the-art technologies allow for considerable lower emission levels (due to recent developments in state-of-the-art technologies, such as dust separation), lower emission limit values (according to state-of-the-art) than the current emission limits are indicated. In that case the indicated values (that are lower than current emission limits) have been agreed on by the competent authority (Magistrat Linz) and by Agrolinz Melamine GmbH. The indicated emission values are based on half-hour mean values.

l) Limit values of the trial operation; definitive setting of limit values is only possible after the end of the trial operation.

Combined waste gas scrubbing of neutralisation/evaporation and granulation units

In 2001, the MN-fertiliser production at Agrolinz Melamine GmbH was renewed. A new combined waste gas scrubber was installed for treating the neutralisation/evaporation exhaust vapours and the off-gases of the Spherodizers. The former waste gas treatment (Venturi scrubber for one – out of two – Spherodizer and co-condensation of the neutralisation/evaporation exhaust vapours and treatment of the NH₃ off-gases by washing with water) was replaced. In addition, a new granulation line was installed, replacing an old Spherodizer that had been installed in 1967. Now, the combined scrubber treats the exhaust vapours from the neutralisation/evaporation unit (without condensation) as well as the off-gases of both Spherodizers. Figure 10 presents a schematic diagram of the combined scrubber.

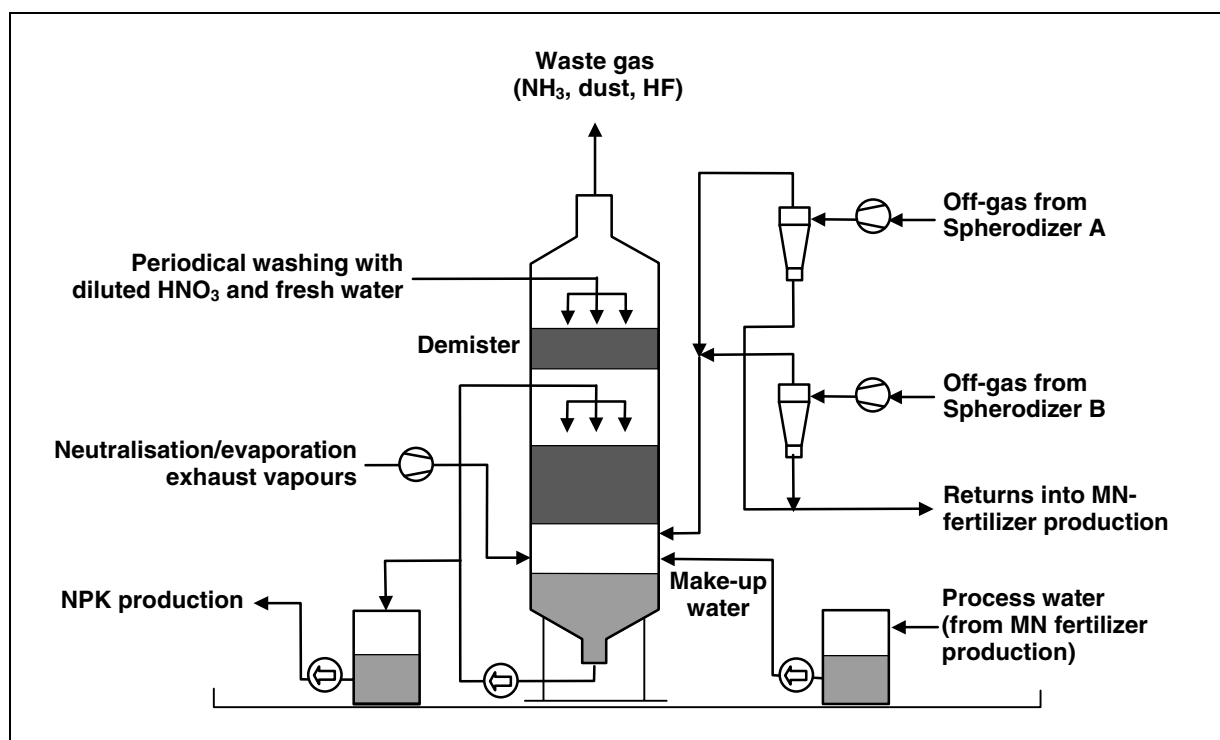

Figure 10: Schematic diagram of a combined scrubber for the neutralisation/evaporation exhaust vapours and the granulation off-gases of the MN-fertiliser production.

The total waste gas volume of the combined scrubber is about 250,000 Nm³/h. Circulation of scrubbing liquor is about 1,800 m³/h. About 1 m³/h scrubbing liquor with an AN concentration of about 25 wt % is drawn off and recycled into the MN-fertiliser production process. Liquid effluents from the MN fertiliser production, which are collected in a process water reservoir, are used as make-up water. The scrubber is equipped with a demister located above the scrubber packing. The combined scrubber has to be cleaned periodically, because insoluble compounds in the waste gas, such as dolomite, CaSO₄ and Ca₃(PO₄)₂, cause clogging of the scrubbing column.

As a result of the renewal project, cross-media effects have been eliminated that occurred as a consequence of the former waste gas treatment. Detailed figures about waste water streams and waste gas streams before and after the revamping project are given in Figure 13 (chapter 4.4.3). In particular, waste water emissions from the neutralisation/evaporation and granulation units are now avoided with the following measures:

- Elimination of the partial condensation of the neutralisation/evaporation exhaust vapours,
- Reduction of liquid effluents from waste gas scrubbing
- Recycling of concentrated scrubbing liquor into the production process.

Table 14 presents waste gas figures of the combined scrubber including raw gas concentrations of the neutralisation/evaporation exhaust vapours and Spherodizer off-gases.

Table 15 presents economic figures of the scrubber for combined treatment of waste gases from two Spherodizers and the exhaust vapours of the neutralisation/evaporation section.

Table 14: Design values of raw gas flow and raw gas concentration of the neutralisation/evaporation exhaust vapours and Spherodizer off-gases, which are treated together with the combined scrubber at Agrolinz Melamin GmbH [Agrolinz 2001].

	Raw gas – Spherodizers A & B		Raw gas – Ammoniation	
	mg/Nm ³	kg/h	mg/Nm ³	kg/h
Dust	150	37	–	–
NH ₃	150	37	5,600	14
NO _x	25	6	60	–
HF	n.a.	n.a.	n.a.	n.a.

Table 15: Economic figures of the scrubber for combined treatment of waste gases from two Spherodizers and the exhaust vapours of the neutralisation/evaporation section [Agrolinz 2002c].

Combined scrubber/Economic figures	
Investment costs	5,6 Mio €
Total operating costs	n.a.
• Maintenance (estimate: about 4 % of the investment costs)	225.000 €/a
• Further details about operating costs are not available	

Product Cooling

As part of the renewal of the granulation process, a plate bank cooler was installed in line A in addition to the rotary drum cooler. In order to achieve a required product temperature of $\leq 32^{\circ}\text{C}$, the plate bank cooler is operated in summer. In winter, these temperatures are achieved by the drum cooler only. Off-gases from the cooling drum are de-dusted with cyclones and used for granulation air. Separated dust is recycled into the neutralisation/evaporation unit. In new line B, a plate bank cooler was installed in order to cool the whole product, so that pre-cooling in a rotary drum cooler is not necessary.

Table 16: Economic figures of the plate bank coolers at Agrolinz Melamin GmbH [Agrolinz 2002c].

Plate bank cooler/Economic figures	
Investment costs:	1,8 Mio € for both lines
Total operating costs	n.a.
• Maintenance (estimate: about 4% of the investment costs)	72.000 €/a
• Operating details	Cooling water: ~ 150 m ³ /h Air: ~ 300 Nm ³ /h

4.4 Waste Water Emissions and Waste Water Treatment (MN-fertiliser and CNTH conversion)

4.4.1 Main Pollutants and Emission Sources

The nitrophosphate process might evolve liquid effluents, mainly as a result of process condensates and scrubbing liquors. Potential emission sources are process waters from neutralisation/evaporation units, scrubbing liquors from off-gas treatment of digestion, and granulation and washing liquors. Pollutants are ammonia, nitrates, fluorides and phosphates, and heavy metals contained in phosphate rock, such as Cd, Hg and Zn.

Ammonia emissions occur when not all condensates of the neutralisation/evaporation can be recycled. The main sources of the nitrate and fluoride emissions are the scrubber liquor of the phosphate digestion and the sand washing. Emissions of phosphates and heavy metals mainly originate from sand washing.

4.4.2 Waste Water Treatment and Measures for Reduction of Waste Water Emissions

Several measures allow for a considerable reduction of waste water emissions from the MN-fertiliser production by the nitrophosphate route. Among these are:

- Recycling of waste water arising from waste gas scrubbing at the phosphate rock digestion;
- Recycling of washing liquor for sand washing;
- Avoidance of the use of co-condensation;
- Recycling of scrubbing liquor from waste gas scrubbing of the ammoniation into the production process;
- Combined waste gas scrubbing of the neutralisation/evaporation and granulation units; (also cf. chapter 4.3.2).

According to [EFMA 2000c], a reduction of N emissions from 1.2 to 0.6 kg N/t P_2O_5 ¹³⁾ and a reduction of emissions of fluorine compounds from 0.7 to 0.02 kg F/t P_2O_5 ¹³⁾ can be achieved by recycling of the NO_x scrubber liquor. The recycling of the sand washing liquor results in a reduction of P-emission from 0.4 kg to 0.02 kg P_2O_5 /t P_2O_5 ¹³⁾.

Process water effluents can be reduced to a large extent when the waste gases arising from the neutralisation are treated together with the hot off-gases of the Spherodizer. A more detailed description of this process is presented in chapter 4.3.2. The process eliminates cross-media effects from scrubbing the Spherodizer off-gas, avoids condensates from the neutralisation/evaporation and enables the recycling of scrubbing and/or washing liquors into the production process to a large degree. Figure 11 presents a water balance for the production of (15/15/15) NPK fertiliser (nitrophosphate route) and CAN fertiliser (cf. chapter 5) without liquid effluents according to [Meyer & Nitzschmann, 1998].

The amount of liquid effluent, which has to be removed from the production process, mainly results from the amount of water, which is introduced into the process with nitric acid. Water is also introduced into the fertiliser production process when washing liquors and/or scrubbing liquors are recycled into the production process. The combined scrubber allows for a high removal of liquid effluents via the gas phase because it works as an evaporator for liquid effluents without additional energy requirements. A major part of the water is removed from the production process through the moisture of the off gases. Liquid effluents from a CAN plant can be used as make-up water for the combined scrubber.

¹³⁾ related to the ton of P_2O_5 produced

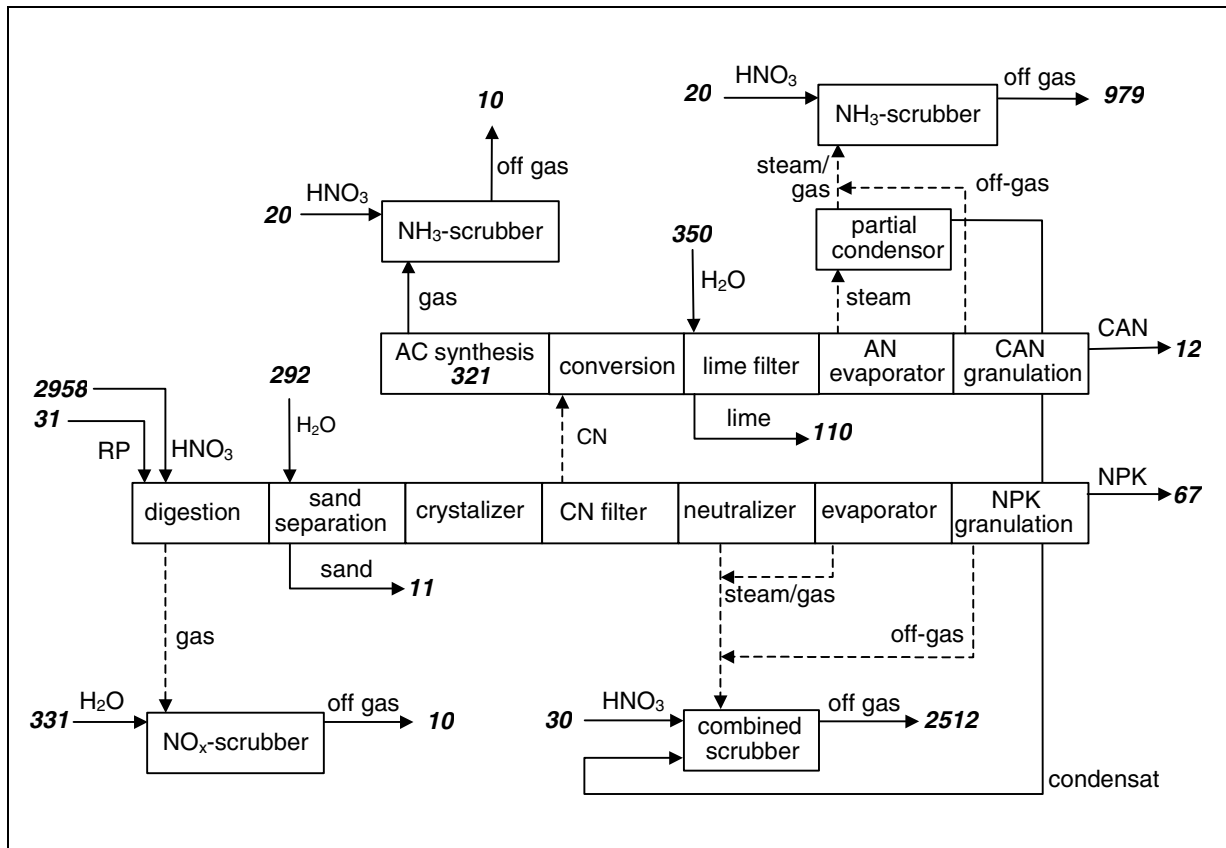

Figure 11: Water balance for the production of (15/15/15) NPK fertiliser (nitrophosphate route) and CAN without liquid process effluents in kg water/ton P_2O_5 [Meyer & Nitzschmann, 1998].

Waste water that cannot be avoided is discharged into running waters after adequate treatment, for example in a biological waste water treatment plant with nitrification/denitrification and phosphoric precipitation.

4.4.3 Reference plant – Agrolinz Melamine GmbH

Waste water emissions from MN production and CNTH conversion

At Agrolinz Melamin GmbH, liquid effluents from neutralisation/evaporation units and from the off-gas treatment of granulation off-gases were eliminated by the installation of a combined waste gas scrubber (also cf. chapter 4.3.3). Figure 12 and Figure 13 present waste gas and waste water streams of the fertiliser production before and after renewal.

Before renewing the granulation plant, about 2,500 m³/d process effluents were discharged from co-condensation of the neutralisation/evaporation exhaust vapours. About 750 m³/d scrubbing liquor was discharged from the Venturi scrubber treating the granulation off-gases of Spherodizer A. Since the renewal of the granulation plant, these waste water streams were eliminated, also resulting in a considerable reduction of load. Scrubbing liquor, which arises from the combined waste gas scrubber an amount of 1 m³/h, can now be recycled into the NPK production process.

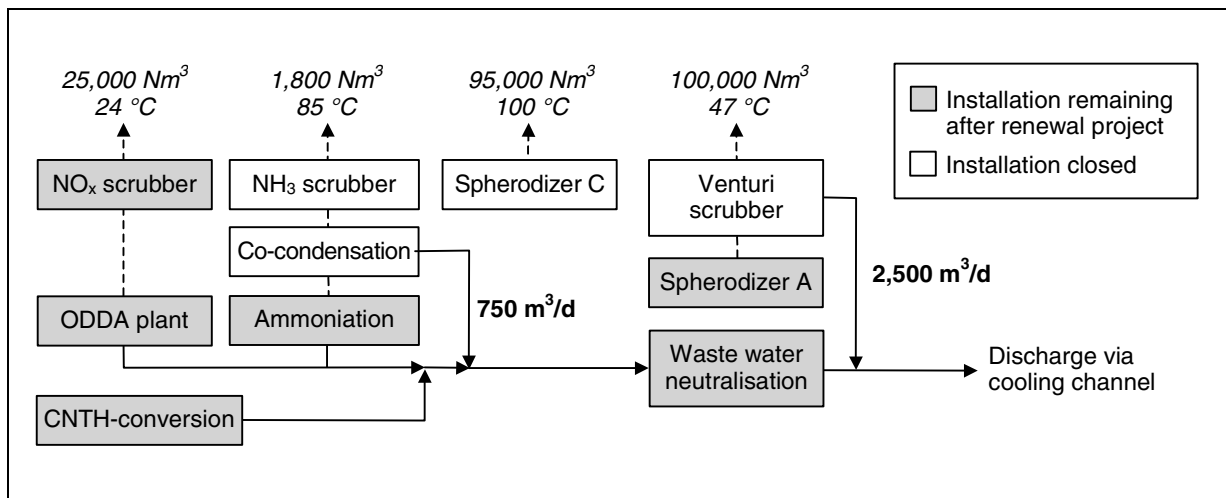

Figure 12: Waste gas and waste water streams of the ODDA plant at Agrolinz Melamin GmbH before renewal of the granulation unit.

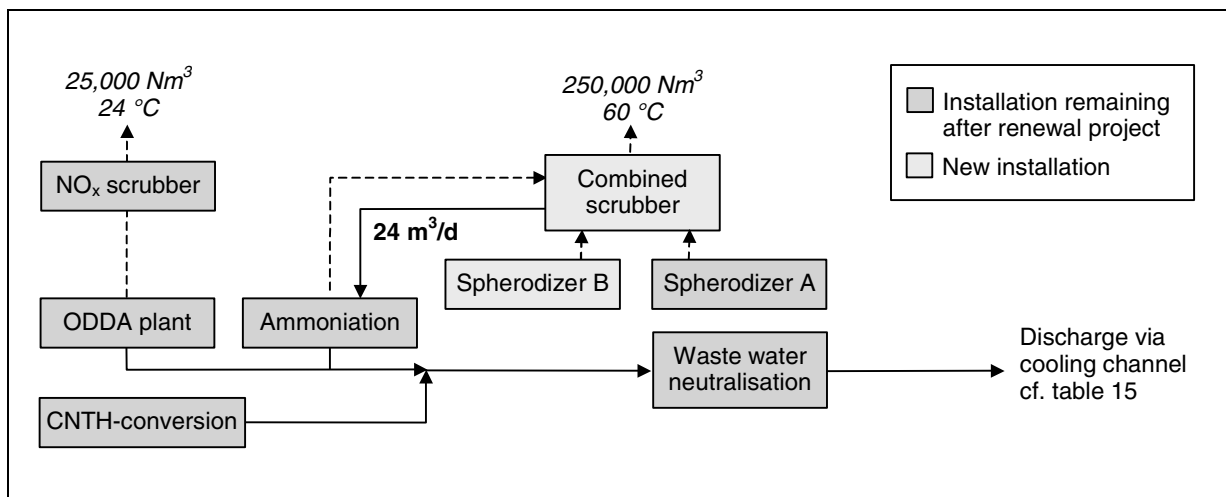

Figure 13: Waste gas and waste water streams of the ODDA plant at Agrolinz Melamin GmbH after renewing the granulation unit.

Table 17 presents the actual waste water emissions from the production of NPK fertiliser (nitrophosphate route) at Agrolinz Melamine GmbH. Waste water arising from the CNTH conversion is collected together with waste water from the ODDA plant. Waste waters are neutralised and discharged into the cooling channel (i.e. into running waters).

Cleaning of the combined waste gas scrubber

The combined scrubber for the granulation and neutralisation/evaporation off-gases was to be expected to be cleaned every 2 months, because insoluble compounds of the waste gas cause clogging. Diluted acids or alkaline solutions are used for cleaning. Waste water from cleaning is recycled into the MN-fertiliser production.

Table 17: Waste water emissions from the production of MN-fertilisers (including CNTH conversion) at Agrolinz Melamin GmbH, current emission limits and emission limits according to the ministerial order for the limitation of wastewater emissions from the production of inorganic fertilisers [Agrolinz 2001], [AEV Dü ngemittel 1996], [Magistrat Linz 2002b].

Parameter	Waste water emissions levels		Current emission limits ^{b)}	AEV Dü ngemittel ^{c)}
Volume (excluding cooling water)	3,457 m ³ /d		10,177 m ³ /d	
pH	6.8		6-8	
Filterable substances	215 kg/d	1.47 kg/t P ^{a)}	150 kg/d	5 kg/t P
PO ₄	77 kg/d	0.53 kg/t P ^{a)}	500 kg/d	0.6 kg P/t P
NH ₄ -N	100 kg/d	0.68 kg/t P ^{a)}	500 kg/d	2.0 kg/t N
NO ₃ -N	124 kg/d	0.85 kg/t P ^{a)}	1,000 kg/d	2.0 kg/t N
NO ₂ -N	2 kg/d	0.01 kg/t P ^{a)}	10 kg/d	0.05 kg/t N
Fluoride	43 kg/d	0.29 kg/t P ^{a)}	180 kg/d	4 kg/t P
Cd	1.4 g/d	0.01 g/t P ^{a)}	25 g/d	0.2 g/t P
Hg	n.a.	n.a.		0.02 g/t P ^{d)}
Zn	n.a.	n.a.		4.0 g/t P

^{a)} Calculation based on the a production capacity of 146 t P/d (corresponding to production capacity of 1,200 t/d MN fertiliser and a P₂O₅ content in the MN fertiliser of 28 %)

^{b)} Consensus for the discharge of waste water from the ODDA process (production of MN-fertiliser and CNTH conversion) into the combined cooling water channel. The parameters NO₂-N, NH₄-N, NO₃-N, fluoride, filterable substances and PO₄ have to be measured daily; Cd (additionally Hg and Zn) have to be measured monthly; pH and waste water volume have to be recorded continuously. The consensus will be revised in the near future. [Magistrat Linz 2002b].

^{c)} Emission limits for the discharge of wastewater into running waters according to the ministerial order "AEV anorganische Dü ngemittel", which will apply since the end of 2002. Emission values refer to the installed product capacity (as tons P of the product or as tons N of the product). For further details, such as monitoring and sampling requirements, please be referred to chapter 8.1.4.

^{d)} If the content of mercury in the rock phosphate is above 0.1 g/t, the emission value will be 0.06 g/t.

4.5 Waste and Residues

Insoluble material arises from the digestion of phosphate rock. It mainly consists of quartz sand. The amount of sand depends on the composition of the phosphate rock. After separation, washing and drying, sand either can be used as a building material or is disposed of.

5 AMMONIUM NITRATE AND CALCIUM AMMONIUM NITRATE

5.1 Production Processes

5.1.1 Production of Ammonium Nitrate (AN) by Neutralisation of HNO₃ and NH₃

Ammonium Nitrate (NH₄NO₃; AN) is produced by neutralisation of ammonia and nitric acid. The neutralisation reaction is highly exothermic and proceeds with high speed.



This considerable heat of reaction can be used for partial or complete evaporation of the water. The heat will be utilised most efficiently if neutralisation is carried out under pressure. Depending on operating pressure and concentration of the nitric acid, solutions with a concentration of up to 95-97% ammonium nitrate can be obtained without additional energy required. [Zapp, 2001].

Several different types and designs of neutralisers are in operation. During neutralisation, the components must be mixed quickly and thoroughly in the reactor to avoid local overheating, losses of nitrogen, and decomposition of the ammonium nitrate [EFMA 2000a], [Zapp, 2001].

As nitrogen fertilisers based on ammonium nitrate are limited with a maximum nitrogen content of 28 % by Austrian Fertiliser Law, the production of AN fertilisers is not taken into account within the present study.

Reference plant: At Agrolinz Melamine GmbH ammonium nitrate is produced by pressure neutralisation. The neutraliser is a loop reactor and operates at a working pressure of about 4.5 bar and a working temperature of approx. 180 °C. Preheated gaseous ammonia and nitric acid (59.7 %) is supplied into the ammonium nitrate solution, which circulates through the loop reactor. In a separator installed at the top of the loop reactor superheated steam is separated from the AN solution. The ammonium nitrate solution drawn off the reactor has a concentration of approx. 74-76 %.

Process water is injected into the superheated steam, which is cooled to 153 °C, i.e. the temperature of saturated steam. Condensate arising from the injection of process water contains NH₃ and AN and is recycled into the loop reactor. The saturated steam is used for concentrating the NH₄NO₃ solution in a first vacuum evaporator. An NH₄NO₃-solution with a concentration of approx. 96 % is achieved without any additional heat input. Excess steam is used for other heating purposes.

In a second vacuum evaporator step, the concentration of the NH₄NO₃-solution is increased to about 98.5 % using high-pressure steam. Two evaporation lines are operated. One line produces pure AN melt. The other evaporation line is used for the concentration of AN solution produced by CNTH conversion together with residual part of the AN produced by pressure neutralisation.

At Agrolinz Melamin GmbH, a major part of the produced AN is processed into CAN fertiliser. Additionally, pure AN melt is used for the production of technical grade AN prills (cf. chapter 0).

5.1.2 Production of ammonium nitrate by the conversion of by-product CNTH from the ODDA process

For the production of AN by the CNTH conversion please be referred to chapter 4.1.3.

5.1.3 Production of Calcium Ammonium Nitrate (CAN) Fertilisers

Calcium ammonium nitrate (CAN) is produced by mixing ammonium nitrate solution obtained

- from the neutralisation of NH_3 and HNO_3 (cf. chapter 5.1.1) and/or
- from the conversion of by-product CNTH of the ODDA process (cf. chapter 4.1.3)

with a filler, containing dolomite, calcium carbonate, ground limestone or, quite frequently, by-product calcium carbonate from a nitrophosphate plant.

The production of nitrophosphate fertilisers by digestion of phosphate rock with nitric acid in the ODDA process produces as a by-product calcium nitrate tetra hydrate. The conversion of calcium nitrate tetra hydrate crystals with NH_3 and CO_2 results in the production of AN and lime, which can be used for the production of CAN. For a more detailed description of the CNTH conversion please be referred to chapter 4.1.3.

Figure 14 presents a block diagram of the production of CAN by conversion of CNTH (by-product of the ODDA process). After concentration, the AN solution produced by the conversion of CNTH is usually used for the production of calcium ammonium nitrate fertilisers. The separated CaCO_3 still contains small amounts of ammonium compounds and phosphate and is mostly used for the CAN production.

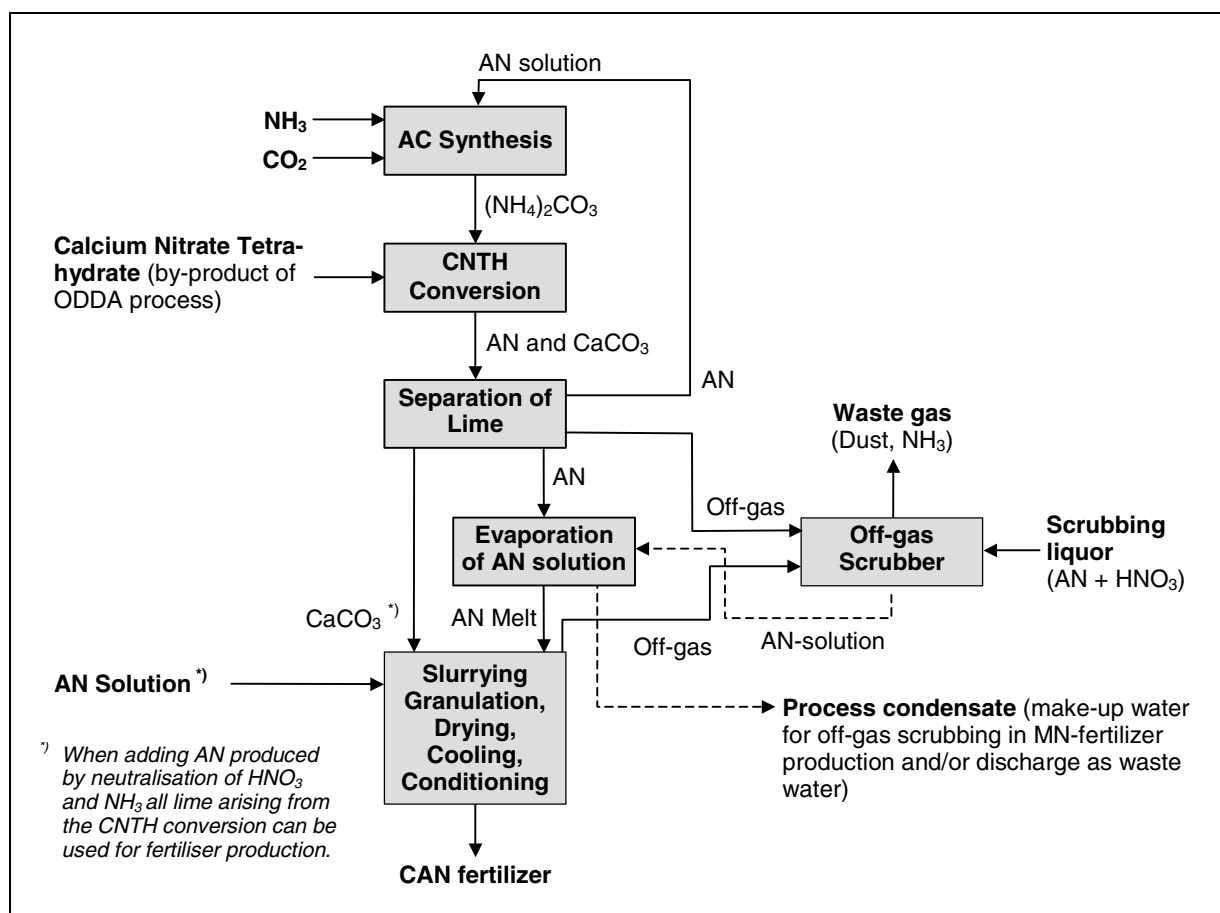

Figure 14: Block diagram of the production of CAN fertilisers by conversion of CNTH.

When producing AN in an additional AN synthesis, all lime arising from the CNTH conversion can be used for fertiliser production. An additional AN synthesis also maintains continuity of AN availability during ODDA section shutdown or during non-availability of CO_2 from the ammonia plant.

Reference plant: At Agrolinz Melamin GmbH calcium ammonium nitrate (CAN) fertilisers are produced by mixing concentrated ammonium nitrate solution and lime both coming from the CNTH conversion (cf. chapter 4.1). Ammonium nitrate solution coming from pressure neutralisation is also used for CAN production. Lime arising from the conversion of CNTH is directly used without washing and drying.

5.1.4 Finishing Processes

Finishing processes used for AN or CAN fertiliser are prilling or granulation processes.

Prilling starts from melts containing about 0.5 % water. At the top of the prill tower AN solution is sprayed into the tower, thereby forming droplets. Cold air is drawn through the tower counter-currently to remove the heat evolved on crystallisation. As the droplets fall through the tower, they solidify into round granules [Conradson, 2000]. At Agrolinz Melamin GmbH, prilling is used for the production of technical grade AN (cf. chapter 0).

Several processes exist for the **granulation** of AN and CAN fertilisers [EFMA 2000a]. Granulation in a rotary drum starts from a slurry, which is sprayed onto a dense curtain of returns (undersized and crushed oversized particles). Screening of granulates is performed in order to retrieve the desired material size. The granulated products are dried and cooled and coated with anti-caking agents.

Reference plant: At Agrolinz Melamin GmbH, CAN-fertilisers are produced by rotary drum granulation. For feedstock, a slurry of 98,5% ammonium nitrate solution and lime is used. AN solution is obtained from both pressure neutralisation and CNTH conversion. Lime is directly taken from the conversion of CNTH without washing or drying. Steam is used for adjusting the granulation temperature of 140-147 °C. The addition of crushed limestone, gypsum and/or Mg-salts might be necessary in order to obtain the specific product composition. The product is dried with a rotary dryer in an autothermal process. Dust is removed from the off-gas streams by cyclones and recycled into the production. Off-gases of the granulation and drying drums are treated in a wet scrubber together with other off-gases of the CAN production, such as non-condensable off-gases arising from the AN production (cf. chapter 5.3.3).

5.1.5 Production of Technical Grade Ammonium Nitrate

Though prilling plants for fertiliser-grade ammonium nitrate have a decreasing relevance compared to granulation processes, prilling is still the state-of-the-art process for technical grade ammonium nitrate. For the production of technical grade prills the ammonium nitrate melt is mixed with a prilling additive and pumped to the prilling tower top. From here the melt is sprayed in droplets which crystallise in a countercurrent cool air stream. The prills are then sequentially dried in rotating drums, screened, cooled in a fluidised-bed cooler and coated with an anti-caking agent. Off-spec material is redissolved and recycled to the process. Waste gases are scrubbed and can be re-used, which significantly reduces waste air flow [Krupp Uhde 2001].

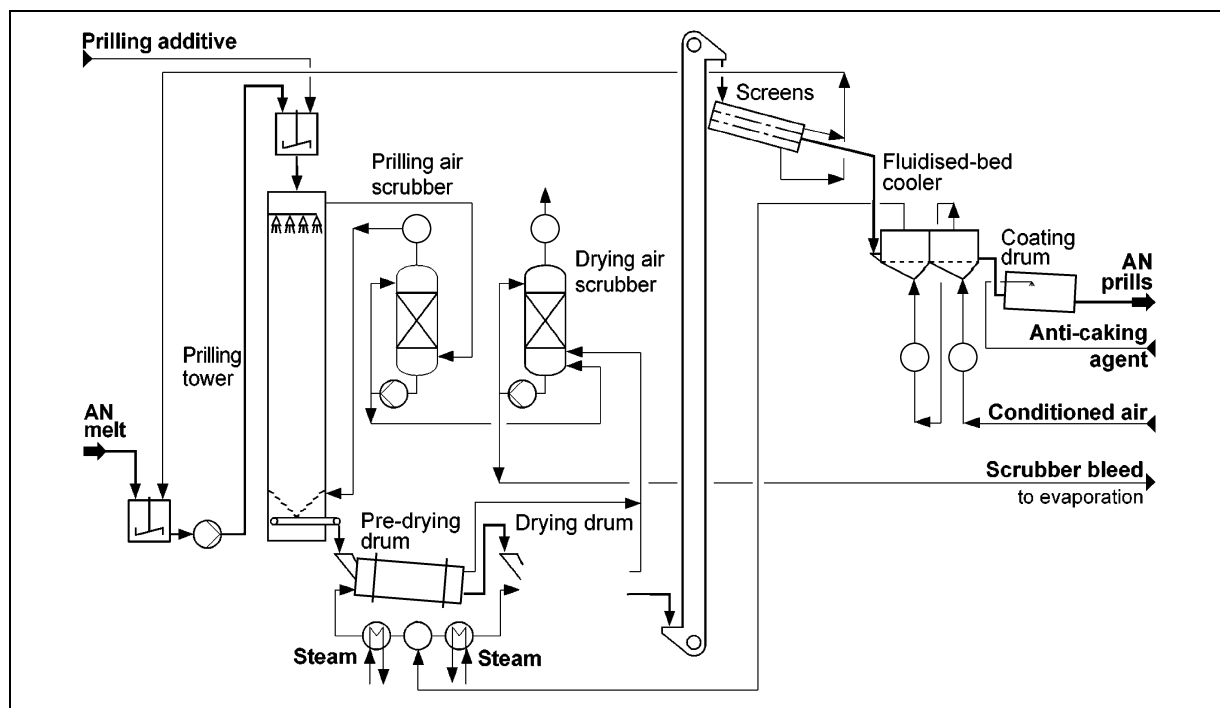

Figure 15: Schematic diagram of the production of technical grade ammonium nitrate [Krupp-Uhde 2001].

Reference plant: At Agrolinz Melamin GmbH about 14,600 t/a technical grade ammonium nitrate is produced by prilling. Starting material is 97,5 % AN melt, which is derived after the second evaporation step of the pressure neutralisation process (cf. chapter 5.1.1). The AN melt is concentrated in falling film evaporators, which are installed at the top of a prill tower and are operated in counter current with hot air. The falling film evaporators concentrate the AN melt to about 99.8 %. The hot concentrated AN melt is sprayed via nozzles into the prill tower, where cooling air conducted in counter current causes solidification of the AN prills. The AN prills are finally cooled in a cooling drum.

Waste gases from the falling film evaporators and the prill tower are treated in a packed column. About 90 % of the purified waste gas is recycled into the prill tower. The rest of the waste gas is used for cooling the product and is finally treated with an aerosol filter. For a more detailed description of the waste gas treatment please be referred to chapter 5.4.3.

5.2 Resources

5.2.1 Input/Output Levels

Table 18 presents input/output levels of the ammonium nitrate production at Agrolinz Melamin GmbH.

The production of 1 ton calcium ammonium nitrate (CAN) fertiliser with 27 % N requires 770 kg ammonium nitrate (100 % NH_4NO_3), 212 kg lime (dry) for scrubbing solution. At Agrolinz ammonium nitrate obtained from CNTH conversion and ammonium nitrate obtained from pressure neutralisation are used for the production of CAN fertilisers. Lime is mainly taken from the conversion of CNTH [Agrolinz, 2001]. Additionally ammonium sulphate (in 2002: 2,900 tons), dolomite and/or lime stone (in 2002: 36,600 tons) and anti-caking agents (in 2002: 635 tons) is used [Agrolinz 2002c].

Table 18: Input/output levels of the ammonium nitrate production at Agrolinz Melamin GmbH [Agrolinz 2002c].

Production	Production 100 % AN (t/a)	Production capacity (t/d)	Raw materials	Input (t/a)
Ammonium nitrate from pressure neutralisation	372,000	1,800	NH ₃	79,100
			HNO ₃	293,000
Ammonium nitrate from CNTH conversion	143,500 ^{a)}	890	Ca(NO ₃) ₂ ·4H ₂ O	248,000 ^{a)}
			NH ₃	30,500
			CO ₂	56,300 ^{a)}

^{a)} calculated values

Table 19: Output of CAN fertiliser production at Agrolinz Melamin GmbH [Agrolinz 2001], [Agrolinz, 2002a].

Product	Main compositions	Production (2000)	Capacity [t/d]
Calcium Ammonium Nitrate (CAN)	27% N	663,000 t	2,200 t/d

5.2.2 Energy and Cooling Water

Neutralisation of HNO₃ and NH₃

Steam is released from the neutraliser as a consequence of the heat of reaction arising from the reaction of HNO₃ with NH₃. The steam can be used for concentrating the ammonium nitrate solution in the first evaporation step if the neutralisation proceeds under pressure. With pressure neutralisation, the production of an AN-solution with approx. 95 % AN is achievable without additional energy demand for evaporation. Excess steam can additionally be used for various heating purposes, such as heating of the desorption column for the removal of NH₃ from process steam condensate or for the production of warm water [Agrolinz 2001].

Considerable amounts of cooling water are required for the neutralisation of HNO₃ and NH₃. Cooling water is mainly required for condensing process steam and exhaust vapours. At Agrolinz Melamin GmbH, about 24.500 m³/d cooling water ($\Delta T = 10$ °C) are required.

Production of CAN fertilisers

Table 20 presents the specific energy consumption for the production of CAN at the reference plant Agrolinz Melamin GmbH. Steam is required for the concentration of the AN solution in a second evaporation step and for adjusting the granulation temperature.

Table 20: Specific energy consumption for the production of CAN [Agrolinz 2001].

energy	energy consumption
Electric energy	13.2 kWh/t CAN
Steam	0.013 t/t CAN

5.3 Emissions to Air and Waste Gas Treatment

5.3.1 Main Pollutants and Emission Sources

Main air emissions arising from the production of AN and CAN fertilisers are dust (ammonium nitrate) and ammonia. Main sources of ammonia emissions are the formation and concentration of AN solution (neutralisers and evaporators) and finishing operations (granulation or prilling). Dust (largely as ammonium nitrate) is emitted from most of the process operations. If exhaust vapours from neutralisers and evaporators are (partly) condensed, liquid process effluents arise (oder: effluent arises) instead of waste gases.

5.3.2 Air Pollution Abatement and Waste Gas Treatment

AN neutralisation

Steam arising from the neutralisation reactor is contaminated with AN, ammonia and HNO_3 . Specific plant operating characteristics, however, make emissions vary depending on the use of excess ammonia or acid in the neutraliser. An acidic solution of ammonium nitrate is more unstable than an alkaline solution.

Steam leaving the neutraliser is purified, optionally after condensation. For steam purification a combination of droplet separators and scrubbers is used in order to remove ammonium nitrate emissions. Scrubbers require the addition of acid, normally nitric acid, in order to neutralise any free ammonia and to optimise its removal. [EFMA 2000a], [UNEP/UNIDO/IFA, 1998].

Steam arising from the production of AN by pressure neutralisation condenses when using it for concentrating the AN solution. As a cross-media effect, liquid process effluents arise, which require adequate treatment (cf. chapter 5.4). Non-condensable waste gases are treated by wet scrubbing. When producing CAN, the residual waste gas streams can be treated together with the off-gas streams of the granulation process.

Production of ammonium nitrate by the conversion of by-product CNTH from the ODDA process

For waste gas emissions arising from the production of AN by the CNTH please be referred to chapter 4.3.2.

Production of CAN fertilisers

Emissions from solid formation processes are ammonium nitrate particulate matter and ammonia. Ammonia is normally removed by neutralisation in a wet scrubber.

Serious emission problems attributable to ammonium nitrate fumes are often encountered in prilling on account of the large air throughput [Zapp 2001]. Ammonium nitrate fume gives a persistent blue haze which can be seen at a long distance from the plant. In AN fertiliser plants, ammonium nitrate fume can be removed by irrigated candle filters (with candles incorporating fine glass fibre). However, this method is not appropriate for prilling CAN fertiliser. [EFMA 2000a].

Compared to prilling, the main differences of granulation with respect to the off-gas treatment are that the quantity of air to be treated is much smaller and abatement equipment is easier to install. Waste gases from granulation and drying operations are de-dusted by cyclones and treated by wet scrubbing. Scrubbing liquors arising from off-gas treatment can be recycled into the fertiliser production. When producing AN by the conversion of CNTH (cf. chapter 4.1.3), emissions of fluorine compounds have to be considered. With waste gas scrubbing emissions of fluorine compounds are below 1 mg/Nm^3 .

5.3.3 Reference Plant – Agrolinz Melamine GmbH

AN pressure neutralisation

Steam that leaves the neutralisation reactor is used for concentrating the AN solution and thereby condenses to a large extent. Ammonia and ammonia nitrate are removed from condensates and recycled into the neutralisation reactor as far as possible. Exhaust vapours of the evaporators are scrubbed and condensed. For the production process please be referred to chapter 5.1.1, for waste water emissions to chapter 5.4.3.

Production of CAN

Waste gases from granulation drum and drying drums are de-dusted in cyclones. Separated dust from the cyclones is recycled into the granulation drum. The following off-gas streams are treated together in a central wet scrubber:

- Off-gases of the CAN production incl. non-condensable off-gases of the AN production
- Off-gases from the conversion of CNTH and
- Off gases from the de-dusting of the building.

In the wet scrubber, dust is removed and NH₃ reacts with the acidic scrubbing liquor (HNO₃ solution). Scrubbing liquor is recycled into the CAN-fertiliser plant. Waste gas from the cooling drums is de-dusted by cyclones. Table 21 presents emission levels of major air emission sources of the CAN production at Agrolinz Melamin GmbH [Agrolinz 2002c], [Agrolinz 2002e].

Table 21: Emission levels of the major air emission sources of the production of CAN fertilisers at Agrolinz Melamin GmbH [Agrolinz 2002c], [Agrolinz 2002e], [Magistrat Linz, 2002a].

Emission source	Pollutant	Emission levels			Permit/ Emission limits according to state-of-the-art ^{h)} [mg/Nm ³]
		Emission value 2001 (2000) [mg/Nm ³] ^{a)}	Annual load 2001 (2000) [t/a]	Emission factor [g/t product] ^{f)}	
Central waste gas scrubber K-360 (waste gas volume 92,250 Nm ³ /h)	Dust ^{b)}	14.5 (14.8)	11.0 (10.0)	17.4	< 25
	NH ₃ ^{b)}	1.30 (5.07)	0.99 (3.42)	1.6	< 20
	F as HF ^{b)}	0.44 (0.40)	0.33 (0.27)	0.5	< 1
Cooling drum IV (waste gas volume 107,750 Nm ³ /h)	Dust ^{c)}	6.5 (5.0)	5.80 (4.11)	13.5 ^{g)}	< 25
	NH ₃ ^{c)}	2.75 (3.65)	2.45 (3.00)	6.7 ^{g)}	< 20
Cooling drum V ^{d)} (waste gas volume 91,500 Nm ³ /h)	Dust ^{c)}	5.00 (5.00)	2.77 (2.18)	^{g)}	< 25
	NH ₃ ^{c)}	3.20 (3.05)	1.77 (1.33)	^{g)}	< 20
Other emission sources	Dust	^{e)}	<0.01 (<0.01)	–	< 20

^{a)} Emission concentrations from the annual emission report 2001; Indicated emission values are averages on measured half-hour mean values.

^{b)} Measurements 4 times/a

^{c)} Measurements 2 times/a

^{d)} Cooling drum V is only operated when high cooling capacities are required.

^{e)} Various single emission sources with measurements

^{f)} Calculation referring to the annual CAN fertiliser production of 635.000 t/a

^{g)} Specific emissions (g/t product) have been calculated from both cooling drums

^{h)} The indicated emission values mostly represent emission limit values of the installations at Agrolinz Melamin GmbH. In case of state-of-the-art technologies allow for considerable lower emission levels (due to recent developments in state-of-the-art technologies, such as dust separation), lower emission limit values (according to state-of-the-art) than the current emission limits are indicated. In that case the indicated values (that are lower than current emission limits) have been agreed on by the competent authority (Magistrat Linz) and by Agrolinz Melamin GmbH. The indicated emission values are based on half-hour mean values.

Production of technical grade ammonium nitrate

Off-gases released from Prill tower (about 90,000 Nm³) and the falling film evaporators (about 1,400 Nm³) contain AN dust and NH₃. Off-gases from the prill tower are treated by wet scrubbing in a packed column. In the scrubber, NH₃ reacts with HNO₃, which is added to the AN scrubbing solution dependent on the pH.

After off-gas treatment, a major part of the cleaned air is recycled as cooling air into the prill tower. The recirculating air is pre-heated in order to prevent remoistening. The rest of the off-gas (about 10,000 Nm³) is used for cooling the AN product to about 35 °C and is finally cleaned in an aerosol filter subsequent to the cooling drum. Table 22 presents emission levels of the production of prilled AN (technical grade).

Table 22: Emission levels of the production of technical grade ammonium nitrate at Agrolinz Melamin GmbH [Agrolinz 2001].

Pollutant	Emission levels			Permit/Emission limits according to state-of-the-art ^{d)} [mg/Nm ³]
	Emission value 2001 (2000) [mg/Nm ³] ^{a)}	Annual load 2001 (2000) [t/a]	Emission factor [g/t product] ^{c)}	
Dust (AN) ^{b)}	5.0 (5.0)	0.26 (0.26)	20.5	< 25
NH ₃ ^{b)}	6.55 (4.25)	0.34 (0.22)	13.7	< 20

^{a)} Emission concentrations from the annual emission report 2001; Indicated emission values are averages on measured half-hour mean values.

^{b)} Measurements 2 times/a

^{c)} Calculation referring to a production of 14,600 t/a

^{d)} The indicated emission values mostly represent emission limit values of the installations at Agrolinz Melamin GmbH. In case of state-of-the-art technologies allow for considerable lower emission levels (due to recent developments in state-of-the-art technologies, such as dust separation), lower emission limit values (according to state-of-the-art) than the current emission limits are indicated. In that case the indicated values (that are lower than current emission limits) have been agreed on by the competent authority (Magistrat Linz) and by Agrolinz Melamin GmbH. The indicated emission values are based on half-hour mean values.

Off-gas treatment of the technical grade ammonium nitrate production has been installed at Agrolinz Melamin GmbH in 1995/96. Table 23 presents economic figures of this measure.

Table 23: Investment and maintenance costs of the off-gas treatment of the technical grade ammonium nitrate production [Agrolinz 2002c].

Off-gas treatment of the technical grade ammonium nitrate production/Economic figures	
Investment costs	1.35 Mio €
Total operating costs	n.a.
• Maintenance (estimate: about 4% of the investment costs)	53,700 €/a
• Further details about operating costs are not available	

Waste water does not arise from waste gas scrubbing, as scrubbing liquor is recycled into the CAN production process. Some waste water (< 0,1 m³/h) arises from moistening the aerosol filter in order to avoid coating of the filter with AN.

Generally, the process described above can also be installed at AN fertiliser plants. [Lopez-Nino et al. 1990] described a similar process used for treating waste gas from the prill tower of an AN-plant for producing fertilisers. According to this process, prill tower air is cooled, cleaned, and recycled into the prill tower.

5.4 Waste Water Emissions and Waste Water Treatment

5.4.1 Main pollutants and emission sources

Main pollutants arising from AN production by neutralisation of HNO_3 and NH_3 are $\text{NO}_3\text{-N}$ and $\text{NH}_4\text{-N}$. Main emission sources of waste water are

- process waters arising from condensing the steam leaving the neutralisation reactor and
- exhaust vapours arising from the evaporation of AN solution.

Usually, liquid effluents do not arise from scrubbing the waste gases of the granulation and drying operations, as scrubbing liquors can be recycled into various fields of the fertiliser production.

5.4.2 Measures for the Reduction of Waste Water

AN neutralisation

By the application of closed circuits for recirculation of concentrated process effluents and by a combination of scrubbers, demisters and strippers for steam/condensate purification ammonia and ammonium nitrate can at least partly be recycled into the synthesis section. Purified process condensate can be used for waste gas scrubbing or can partly be recycled in other plants. Examples are the use of process water for a nitric acid production or for scrubbing water in a nitrophosphate plant. Process water that cannot be recycled is discharged after adequate waste water treatment.

CAN production

Scrubbing liquors arising from waste gas treatment of granulation processes can be recycled into the production process.

5.4.3 Reference Plant – Agrolinz Melamine GmbH

Production of ammonium nitrate by pressure neutralisation

At Agrolinz Melamin GmbH process water is injected into the superheated steam leaving the AN pressure neutralisation loop. Condensate arising from this measure is recycled into the neutralisation reactor. The resulting saturated steam is used for concentrating the AN solution in a first evaporation step. As the steam is used for concentrating the AN solution, it condenses. The condensate contains AN and ammonia, because the neutralisation reaction is carried out under ammonia excess. Ammonia and ammonium nitrate are recovered and returned into the neutralisation reactor. Remaining condensate is collected in a process water buffer reservoir. Excess steam is used for other heating purposes. Non-condensable off-gases are treated together with waste gases arising from CAN production (cf. chapter 5.3.3).

Exhaust vapours leaving the first evaporator contain AN and NH_3 . They are washed with an acidic HNO_3 solution in a scrubber equipped with a demister. Circulating washing liquor is partly returned into the neutralisation reactor. The cleaned exhaust vapours are condensed and collected in the process water reservoir. Exhaust vapours leaving the second evaporator are condensed and recycled into the CNTH conversion plant. Non-condensable gases are treated together with waste gases arising from CAN production (cf. chapter 5.3.3).

Process effluents collected in the process water reservoir are partly used for nitric acid production¹⁴⁾ and/or are recycled into other fields of fertiliser production as far as possible. The rest is discharged into running waters. Table 24 presents waste water emissions arising from the AN pressure neutralisation.

Table 24: Waste water emissions from the AN pressure neutralisation at Agrolinz Melamin GmbH, current emission limits and emission limits according to the ministerial order for the limitation of wastewater emissions from the production of inorganic fertilisers [Agrolinz 2001], [Magistrat Linz 2002b], [AEV Düngemittel 1996].

Parameter	Emission levels		Limit value ^{a)}	AEV Düngemittel ^{c)}
Waste water volume	6 m ³ /h	0.24 m ³ /t N ^{b)}	20 m ³ /h ^{d)} or 480 m ³ /d	1 m ³ /t N
total N (NH ₃ -N + NO ₃ -N)	16 kg/d	0.026 kg/t N ^{b)}	60 kg/d or 108 kg/d ^{d)}	
NH ₄ ⁺ as N	n.a.	n.a.	–	0.5 kg/t N
NO ₃ ⁻ as N	n.a.	n.a.	–	0.5 kg/t N
NO ₂ ⁻ as N	n.a.	n.a.	–	0.02 kg/t N

^{a)} The waste water volume has to be recorded, the parameter total N has to be measured weekly

^{b)} Calculation based on the a production capacity of 612 t N/d (corresponding to a production capacity of 1.800 t AN/d and a N-content in the AN of 34 %)

^{c)} Emission limits for the discharge of wastewater into running waters according to the ministerial order “AEV anorganische Düngemittel”, which will apply since the end of 2002. Emission limits refer to the installed product capacity (as tons N of the product). For further details, such as monitoring and sampling requirements, please be referred to chapter 8.1.4.

^{d)} 35 m³/h if waste water cannot be reused

Production of ammonium nitrate by the conversion of by product CNTH from the ODDA process

For waste water emissions arising from the production of AN by the conversion of CNTH please be referred to chapter 4.4.3.

CAN production

Scrubbing solution arising from the central waste gas scrubber is totally recycled into the CAN production process.

¹⁴⁾ The process condensate mainly contains AN and can be supplied to the nitric acid absorption column. AN impurities can be tolerated, as far as the nitric acid is used for the production of fertilisers.

6 UREA¹⁵

Urea is produced by reacting ammonia and carbon dioxide at elevated temperature and pressure. NH_3 and CO_2 react under the formation of an intermediate stage of ammonium carbamate:

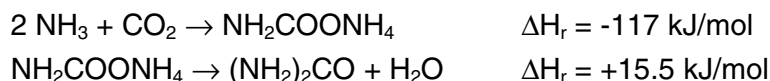

The formation of ammonium carbamate is fast and exothermic, whereas the dehydration of carbamate is slow and endothermic. Since more heat is produced in the first reaction than consumed in the second, the overall reaction is exothermic. The following side reactions have to be taken into considerations for the process design:

- Formation of bi-uret:..... $2 \text{CO}(\text{NH}_2) \rightarrow \text{NH}_2\text{CONHCONH}_2 + \text{NH}_3$;
- Formation of isocyanic acid:..... $2 \text{CO}(\text{NH}_2) \rightarrow \text{NH}_4\text{NCO} \rightarrow \text{NH}_3 + \text{HNCO}$
- Hydrolysis of urea: $\text{CO}(\text{NH}_2) + \text{H}_2\text{O} \rightarrow \text{NH}_2\text{COONH}_4 \rightarrow 2 \text{NH}_3 + \text{CO}_2$

The yield of the urea formation is highly dependent on the reaction temperature and on the NH_3/CO_2 ratio. The ratio of $\text{H}_2\text{O}/\text{CO}_2$ also has an influence on the yield of urea. Yields between 60 and 70 % urea are usual. Industrial production processes mainly differ with regard to the separation and decomposition of unconverted ammonium carbamate and with regard to the recovery and recycling of NH_3 and CO_2 .

6.1 Production Processes

Nowadays only “Total Recycle Processes” are in operation, which recycle essentially all of the unconverted carbamate into the reactor. Figure 16 presents a simplified block diagram of urea production according to “Total Recycle Processes”, which can be classified in:

- Conventional processes
- Stripping processes

Main advantages of stripping processes are that unconverted NH_3 and CO_2 occur via the gas phase, so that none of these recycles is associated with a large water content to the synthesis zone. In addition, stripping processes allow an efficient use of energy within the production process. With the development of stripping processes, the importance of conventional processes has decreased. Among stripping processes, the Stamicarbon stripping process and the SNAM Progetti stripping process are the most common ones. The following chapters 6.1.2 and 6.1.1 in particular refer to these processes. Other stripping processes are the ACES (Advanced Cost and Energy Saving) process and the Isobaric Double Recycling (IDR) process; the latter has in particular been applied in the renewal of older conventional plants [Meessen & Petersen, 1996].

¹⁵ This chapter has been adapted from [Sammer and Schindler, 2001]

NH₃ and CO₂ are recovered in two following stages: The second stage works with medium pressure (~15 bar) and the third stage works with low pressure (~5 bar). The condensation energy of the high pressure section and of the medium pressure section is recovered for steam production.

6.1.2 Stamicarbon CO₂-Stripping Process

Urea synthesis takes place in a reactor at temperatures between 180-185 °C, at a pressure of 140 bar and a molar NH₃/CO₂ ratio of about 3:1. The carbamate is decomposed in a high-pressure stripper, where NH₃ and CO₂ are stripped off. Stripping action is effected by counter-current between urea solution and fresh CO₂ at synthesis pressure. As a result, the partial pressure of ammonia is lowered in the stripper and the main part of carbamate decomposes. In order to remove the residual carbamate from the urea solution, only one low-pressure decomposition step is necessary. The stripped-off NH₃ and CO₂ are subsequently condensed in a high-pressure condenser, thereby forming carbamate solution, which is recycled to the urea reactor. Heat liberated from the carbamate formation is used for the production of low-pressure steam for use in the urea plant itself. Off gases leaving the urea synthesis are washed with carbamate solution in a high pressure scrubber. Non-condensable purge gases are treated by conventional absorption techniques. [EFMA 2001b], [Meessen & Petersen, 1996].

6.1.3 Evaporation and Solid Formation Processes

Prilling or granulation is applied for solid formation of urea. Depending on the requirements of the finishing section, concentration of the urea solution is performed in a single or two-stage evaporator. If prilling is used for finishing, a two-stage evaporation step is required. If granulation is used as solidification step, normally a single evaporation step is sufficient. The residence time in the evaporator must be short, because urea can decompose at the temperature of the evaporator, resulting in the formation of bi-uret. The process condensate obtained from the evaporation step contains urea and ammonia, which are recovered and returned to the process (cf. chapter 6.4.2). Non-condensable purge gases are treated by conventional absorption techniques.

Granulation

Most of the new urea plants use granulation to solidify the urea solution. Compared to prilling the main difference of granulation processes with respect to off-gas treatment is that less cooling air is required and that the dust to be removed is coarser. In addition, a single evaporation step is sufficient, as the concentration of the urea feedstock may be less concentrated (> 95 %) than for prilling. During the granulation, the urea melt is sprayed onto recycled seeds or prills, which are circulated in the granulator. Simultaneously the granule size increases slowly and the melt dries. The melt deposited on the seed material is solidified by air passing through the granulator.

Prilling

The concentrated urea melt (99-99.7 %) is fed to a centrifuge on the top of the prilling tower. There, the urea melt forms liquid droplets, which solidify while they fall through the tower. Cooling air is conducted in counter current. Forced or natural up-draft of ambient air is used for cooling and drying of the liquid droplets.

Reference plant: At Agrolinz Melamin GmbH, the urea solution is concentrated by two staged evaporation. Two vacuum evaporators, one with 0.4 bar and the other with 0.04 bar, are used

to remove water from the urea solution. About 300 kg of process water are produced per metric ton urea. After concentration of the urea solution, there are two options for further processing, depending on the form of urea required. For solid formation, the solution is supplied to the prill tower and for other purposes such as the production of melamine or UAN solution, the molten urea solution is used. A prilling tower is used for the production of solid urea. Molten urea coming from the vacuum evaporators is fed to rotating buckets at the top of the tower. The formed liquid droplets solidify and cool on free fall through the tower. Forced up-draft of air is used for cooling and drying of the liquid droplets.

6.1.4 Urea – Ammonium Nitrate (UAN) Solutions

UAN solutions are produced by mixing the appropriate amounts of urea and AN. At Agrolinz Melamin GmbH UAN solution is produced with 13.5 % AN-N and 13.5 % urea-N.

6.2 Resources and Energy

The SNAM Progetti NH₃ stripping process requires 567 kg NH₃ and 735 kg CO₂ for the production of one ton urea. Other stripping processes require 570 kg NH₃ and 740-750 kg CO₂ for the production of one ton of urea. [EFMA 2001b], [UNEP/UNIDO/IFA 1998]. Ammonia and carbon dioxide are usually obtained from an associated ammonia plant (cf. chapter 2.3). Hydrogen, which is contained in the carbon dioxide feed, is removed by catalytic techniques in order to avoid the formation of explosive mixtures in the off-gas of the plant [Meessen & Petersen, 1996].

Reference data for energy consumption of the Austrian plant is not available. According to [EFMA 2001b] and [UNEP/UNIDO/IFA 1998] typical energy consumption of the NH₃ stripping process is 0.76 t steam (108 bar) and 21.1 kWh per ton urea. Specific energy consumption of the CO₂ stripping process depends on the actuation of the CO₂ compressor. In case of a steam turbine, the CO₂ stripping process requires 0.77 t steam (120 bar) and 21.1 kWh per ton urea. When using an electromotor typical energy consumption per ton urea is 0.8 t steam (24 bar) and 110 kWh.

The CO₂ stripping process requires about 60-70 m³ cooling water per ton of urea. Cooling water amount of the NH₃ stripping process is about 80 m³/t urea. [UNEP/UNIDO/IFA 1998], [EFMA 2001b].

6.3 Emissions to Air and Waste Gas Treatment

6.3.1 Main Pollutants and Emission Sources

Main emissions sources from the production of urea are continuous process vents from the synthesis section containing ammonia, and waste gases from solid formation (prilling or granulation) containing ammonia and dust (solid urea particles). Ammonia emissions result from the decomposition of urea during solid formation. Off-gases from prilling towers contain significant amounts of dust. The ratio of particles with a size below 10 µm is typically rather high in off-gases of prilling towers (cf. Table 25).

Table 25: Dust formation from prilling of urea – causes and typical particle size range in the off-gases of prill towers [EFMA 2001b].

Cause	Particle Size Range Dust	% of Total
Condensation products of urea vapours/aerosols	0.5-2.0 µm	50
Reaction product of NH ₃ and isocyanic acid (HNCO) to form Urea	0.1-3.0 µm	20
Prill satellites and undersize prills	10-100 µm	5
Crushing, abrasion and attrition on the tower floor	1-100 µm	5
Seeding dust	1-20 µm	20

6.3.2 Waste Gas Treatment

Conventional absorption equipment is used for removing ammonia emissions from continuous process vents. Off-gases from solid formation processes are treated by wet scrubbing techniques, in order to reduce ammonia and dust emissions. Process condensate arising from the evaporation of urea solution is usually used for scrubbing liquor. An acidic washing solution can be used for scrubbing liquor, in order to increase the efficiency for NH₃ removal. In that case the scrubbing solution cannot be recycled into the urea production process, due to the high content of ammonium nitrate. The scrubbing liquor can be recycled into fertiliser production processes if there is an fertiliser production at the same site.

Compared to granulation, the main differences of prilling with respect to off-gas treatment are that large off-gas volumes have to be treated and that very fine fume-like dust has to be removed. Wet-impingement type scrubbers have proved successful in waste gas treatment of prill towers. Because of the coarser dust and the smaller air quantities to be handled, wet scrubbers provide adequate and much simpler waste gas treatment for granulation units compared to waste gas treatment of prill towers. Many new urea plants use granulation instead of prilling as the finishing technique [Meessen & Petersen, 1996].

6.3.3 Reference Plant – Agrolinz Melamine GmbH

At Agrolinz Melamin GmbH a wet scrubbing system was retrofitted for the waste gas treatment of the prill tower. The waste gas of the prill tower, which has a volume of about 300.000 to 350.000 Nm³/h, is allocated to six scrubbers. Forced upward-draft has been necessary since the installation of wet scrubbers. For all six scrubbers together, approximately 400 m³/h circular solution and approximately 4 m³/h fresh water are necessary. The circulating solution has a pH-value of 5. Table 26 presents emission levels of the major air emission sources of the urea production at Agrolinz Melamin GmbH.

Table 26: Emission levels of the major air emission sources of the urea production at Agrolinz Melamine GmbH [Agrolinz 2002d], [Agrolinz 2002e], [Magistrat Linz 2002a].

Emission source	Pollutant	Emission levels			Permit [mg/Nm ³]
		Emission value 2001 (2000) [mg/Nm ³] ^{a)}	Annual load 2001 (2000) [t/a]	Emission factor [g/t product]	
Prill tower – Scrubbing system	Dust (urea) ^{b)}	19.4 (16.7)	41.3 (39.7)	0.27	< 30
	NH ₃ ^{b)}	6.4 (7.2)	13.6 (17.1)	0.06	< 30
Inert release	CH ₄ ^{c)}	22.9 (22.9)	33.0 (33.4)	n.a.	–
	NH ₃ ^{c)}	1.73 (1.5)	0.002 (0.002)	n.a.	–
	CO ^{c)}	2.5 (2.5)	3.61 (3.64)	n.a.	–
Emergency valve system	NH ₃ ^{c)}	1.7 (3.7)	0.007 (0.014)	n.a.	–
Central de-dusting unit	Dust (urea) ^{d)}	18.8 (20.0)	0.73 (0.78)	n.a.	< 20
	NH ₃ ^{d)}	19.2 (6.9)	0.74 (0.27)	n.a.	< 20

^{a)} Emission concentrations from the annual emission report 2001; Indicated emission values are averages on measured half-hour mean values.

^{b)} Measurements 4 times/a.

^{c)} Internal operational measurements

^{d)} Annual measurements

Dust emissions range between 15 and 23 mg/Nm³ and ammonia emissions between 3 and 9 mg/Nm³ [Agrolinz 2002d]. Raw gas concentrations of the prill tower off gases before the waste gas treatment are 70-140 mg NH₃/Nm³ and 60-130 mg dust/Nm³ [Sammer & Schindler, 1999].

Off-gas treatment of the urea prill tower has been installed at Agrolinz Melamin GmbH in 1993/94. Table 27 presents economic figures of this measure.

Table 27: Economic figures of the off-gas treatment of the urea prill tower [Agrolinz 1999], [Agrolinz 2002d].

Off-gas treatment of the urea prill tower/Economic figures	
Investment costs	2.9 Mio €
Total operating costs (incl. maintenance, energy and others)	110,000 €/a
• Maintenance	23,700 €/a
• Energy consumption (pressure drop, pumps, additional consumers)	56,700 €/a
• Others (Measurements, cleaning)	15,600 €/a
• No costs arise from disposal of residues, as scrubbing solutions (with AN and urea) are processed in the fertiliser production at the same site.	

6.4 Waste Water Emissions and Waste Water Treatment

6.4.1 Emission Sources and Main Pollutants

Process condensate (about 300 kg H₂O/t urea) is the main source of waste water arising from urea production. The major part of the condensate arises in the evaporation unit. The condensates contain large amounts of NH₃, urea and CO₂, which are recovered from the process condensate and recycled into the urea synthesis. Purified process condensate is sent to a waste water treatment plant or discharged into running waters.

6.4.2 Emission Reduction Measures

Several processes exist for recovering NH₃ and urea (in the form of ammonia) from the process condensate obtained from the evaporation section. Usually, the process condensate is subjected to a combination of desorption and hydrolysis operations in order to decompose urea and to recover ammonia. Most processes use a pre-desorption step for the removal of the first bulk of ammonia and a hydrolysis step in order to decompose urea into ammonia and carbon dioxide. Ammonia remaining in the process condensate is then removed by a final desorption step (steam-stripping or distillation). Ammonia recovered from the process condensate is recycled into the urea production process.

6.4.3 Reference Plant – Agrolinz Melamine GmbH

Treatment of process water

At Agrolinz Melamin GmbH, exhaust vapours from evaporation of the urea solution are washed before they are condensed. Ammonia is separated and recovered from the process water by distillation. By way of distillation, the ammonia concentration in the process condensate is reduced from 37 g/l to 66 mg/l. Table 28 presents specific waste water emissions from the production of urea at Agrolinz Melamin GmbH. Waste water is daily analysed and discharged into the running water together with cooling water. Total waste water amount (incl. cooling water) is 40,000 m³/d.

Table 28: Waste water emissions from urea production at Agrolinz Melamin GmbH, current emission limits and emission limits according to the ministerial order for the limitation of wastewater emissions from the production of inorganic fertilisers [Agrolinz 2002d], [Magistrat Linz 2002b], [AEV Düngemittel 1996].

Parameter	Waste water emission levels		AEV Düngemittel ^{d)}
	kg/d ^{b)}	kg/t N ^{c)}	kg/t N ^{c)}
NH ₄ -N	109 ^{b)}	0.22	0.5
TKN ^{a)}	270 ^{b)}	0.55	–
COD	23.3 ^{b)}	0.05	0.5

^{a)} Total Kjeldahl Nitrogen

^{b)} Measurements of the daily average samples: 1-2 times/week

^{c)} Values refer to the installed product capacity (as tons N of the product).

^{d)} Emission limits for the discharge of wastewater into running waters according to the ministerial order "AEV anorganische Düngemittel", which will apply since the end of 2002. For further details, such as monitoring and sampling requirements, please be referred to chapter 8.1.4.

Recycling of scrubbing solution:

Between 0.3 and 0.4 m³/h concentrated scrubbing solution are withdrawn from the waste gas scrubbers of the prill tower. Due to the high content of ammonium nitrate, the concentrated scrubbing solution cannot be recycled to the urea production process. It is used for fertiliser production at the same site. Table 29 presents concentrations of N-containing components in the scrubbing solution.

Table 29: Concentrations of N-containing components in the scrubbing solution [Agrolinz, 1999].

Compound	Ammonia	Nitrate	Urea
Concentration (calculated as N)	30 g/l	30 g/l	72 g/l

7 DIFFUSE AND NON-PROCESS SPECIFIC EMISSIONS

7.1 Emissions to Air

There are several sources for diffuse emissions at the production of fertiliser. All aspects of phosphate rock processing and finished product handling generate dust, such as mills/grinders, pneumatic conveyors, and screens. Dust emissions arise from loading, unloading or transporting of raw materials, intermediates and products. Diffuse emission of F-compounds might arise from curing of superphosphates. Diffuse emission of NH_3 in particular has to be considered at the production of urea and ammonium nitrate due to several potential sources, such as unfitting sealing elements or failing equipment. Maintenance of the installations is an important factor in order to minimise diffuse NH_3 emissions.

Measures for the reduction of dust emissions are:

- Organisational measures – Reduction of diffuse dust emission from transportation/handling of raw materials, intermediates and production by containment of conveyers, vessels, elevators and by reduction of fall heights. Off-gases, which are collected from conveyors and elevators are de-dusted with cyclones and can be re-used for other operations, such as for granulation air;
- Fabric filters are used to control fugitive dust from bagging operations, where humidities are low. Dust emissions of 5-10 mg/Nm^3 are achievable.
- Storage and handling of raw materials and finished products at roofed-in areas.

Reference plant: At the fertiliser production of Agrolinz Melamin GmbH, off-gases released from conveyors and elevators are collected and combined, and de-dusted with fabric filters. Separated dust is recycled into the process. Cleaned off-gas is used for granulation air. Plants for loading and shipping of fertiliser products are equipped with fabric filters achieving emission levels of 5 mg/Nm^3 . About 1.6-1.7 t dust/a are emitted from loading and shipping of fertiliser products [Agrolinz 2001], [Agrolinz 2002e].

7.2 Waste Water Emissions

Losses from leaks are collected separately from storm-water systems. The collected solutions can be reprocessed as far as they are uncontaminated. At Agrolinz Melamin GmbH, rain water collected from basement waterproofing at the acid tanks is used for process water in the fertiliser production.

7.3 Wastes

There are only few process-specific sources of waste at the production of fertilisers. Non-process specific waste arising at fertiliser production sites, such as waste oils and lubricants, spent batteries, or sludge from waste water treatment, require adequate treatment and/or disposal.

8 APPENDICES

8.1 Legislative Regulations for the Production of Fertilisers in Austria

8.1.1 Emissions to Air

In Austria, the release of air emissions from industrial installations is regulated by the “Gewerbeordnung” (Industrial Code; Federal Law Gazette 194/1994 latest amendments by Federal Gazette I 2000/88). According to the “Gewerbeordnung”, the competent authority is required to limit emissions of atmospheric pollutants to air applying state-of-the-art technologies. Emission limits are set in the official letter granted by the local authority. Explicit regulations for plants producing fertilisers do not exist. For permits to be granted for construction, modification and operation of a plant, the competent authority takes into consideration technical regulations, such as TA-Luft and VDI-guidelines as well as current developments of the industry.

Recently, the new TA Luft 2000 has been adopted by the German Bundesrat (26.4.2002) and by the German Bundeskabinett (26.6.2002). General rules of TA Luft apply for all installations. As there are special provisions for specific installations, these rules have priority to the general rules. Special provisions are set under figure 5.4.4.1q for existing installations for the production of fertilisers (straight- or multi nutrient fertiliser) containing P, N and/or K incl. ammonium nitrate and urea (cf. Table 30)

Table 30: TA Luft, Figure 5.4.4.1q: Special provisions for existing installations for the production of fertilisers (straight- or multi nutrient fertiliser) containing P, N and/or K incl. ammonium nitrate and urea.

Dust	Ammonia
At existing installations, dust emissions in the off-gas of prilling, granulation and drying must not exceed a concentration of 50 mg/m ³	At existing installations, ammonia emissions in the off-gas of prilling must not exceed a concentration of 60 mg/m ³ . At existing installations, ammonia emissions in the off-gas of granulation and drying must not exceed a concentration of 50 mg/m ³ .

8.1.2 General Licensing Requirements

As mentioned above, the application of BAT is mandatory for new plants. Stricter regulations may be imposed, if this is necessary to ensure compliance with EU ambient air quality limit values. In addition, the operation of the plant should not lead to an excess of (Austrian) ambient air quality limit values.

8.1.3 Ambient Air Concentration and Air Quality Management Plans

The Austrian Air Protection Act (Federal Gazette I 115/97 amended by Federal Gazette I 62/2001) establishes ambient air quality limit values for several pollutants for the protection of human health. The Austrian Air Quality Protection Act fully transposes the Air Quality Framework Directive (96/62/EC) and its first two daughter Directives (1999/30/EC and 2000/69/EC). If the sum of the limit value and margin of tolerance was exceeded, and this excess pollution was not caused by an accident, an air quality management plan has to be established. Such a plan might include specific measures for installations, such as

1. Application of Best Available Technology (BAT), according to the date of the entry into force of the action plan.
2. Use of fuels with low emissions;
3. Establishment of specific plans for single plants;
4. Enforcement of emission caps.

8.1.4 Wastewater Regulations

In Austria for each permit adjustment is made by the permitting authorities, based on the local environmental conditions and the technical characteristics of the installation. In case national legislation sets general (minimum) limits, these values are the maximum emissions accepted and have to be met all the time.

The “AEV anorganische Düngemittel” (ministerial order for the limitation of wastewater emissions from the production of inorganic fertilisers as well as phosphoric acid and its salts, Federal Gazette 669/1996) will apply since the end of 2002 and will set emission limits for three different kind of productions:

Annex A: Inorganic nitrogen fertilisers (including ammonium nitrate and urea production);

Annex B: Inorganic phosphoric fertilisers and phosphoric acid from the decomposition of phosphate rock with sulphuric acid;

Annex C: MN-fertilisers by the nitrophosphate route (NP-acid, NP-fertilisers).

Provisions for the production of fertilisers also include provisions for the concentration, granulation and packing of the substances mentioned above and waste water emissions from waste gas treatment and aqueous condensates. The “AEV anorganische Düngemittel” does not apply for the discharge of wastewater and condensates from cooling systems, steam generators and water conditioning. Furthermore, effluents from the production of ammonia, K-fertilisers and phosphoric acid from phosphorus are not concerned. Table 31 presents relevant parameters for the discharge of wastewater according to the “AEV anorganische Düngemittel”.

Emission values of Annexes A-C have to be met within self-monitoring (by the operator) and within external monitoring (by the competent authority or by a an authorised institution). As regards monitoring provisions, mostly the rule “4 out of 5” applies. For more details please be referred to notes a-e of Table 31.

Table 31: Emission limits for the discharge of waste water according to the Austrian ministerial order for the limitation of wastewater emissions from the production of inorganic fertilisers as well as phosphoric acid and its salts (“AEV anorganische Düngemittel”).

Annex Parameter	A: Inorganic nitrogen fertilisers, urea		B: Inorganic phosphoric fertilisers		C: NP-acid, NP-fertilisers	
	Discharge into running waters	Discharge into Public sewerage	Discharge into running waters	Discharge into Public sewerage	Discharge into running waters	Discharge into Public sewerage
General parameters						
1. Temperature [°C] ^{a), d)}	30	35	30	35	30	35
2. Fish toxicity G _F ^{b), c)}	4	†)	4	†)	4	†)
3. Filterable substances ^{a), e)}	30 [mg/l] ^{c)}	150 [mg/l] ^{c)}	50 kg/t ^{h)}	50 kg/t ^{h)}	5.0 kg/t ^{o)}	5.0 kg/t ^{o)}
4. pH ^{a), d)}	6.5-8.5	6.5-9.5	6.0-8.5	6.0-9.5	6.5-8.5	6.5-9.5
Inorganic parameters						
5. NH ₄ ⁺ as N [kg/t] ^{b), c)}	0.5 ^{g)}	0.5 ^{g)}	2.0 ^{l)}	2.0 ^{l)}	2.0 ^{g)}	2.0 ^{g)}
6. NO ₃ ⁻ as N [kg/t] ^{b), c)}	0.5 ^{g)}	0.5 ^{g)}			2.0 ^{g)}	2.0 ^{g)}
7. NO ₂ ⁻ as N [kg/t] ^{a), c)}	0.02 ^{g)}	0.02 ^{g)}			0.05 ^{g)}	0.05 ^{g)}
8. Cd [g/t] ^{b), c), e)}			0.10 ^{j)} 1.0 ^{k)}	0.10 ^{j)} 1.0 ^{k)}	0.2 ^{o)}	0.2 ^{o)}
9. Hg [g/t] ^{b), c), e)}			0.02 ^{j)} 0.2 ^{k)}	0.02 ^{j)} 0.2 ^{k)}	0.02 ^{o), p)}	0.02 ^{o), p)}
10. Zn [g/t] ^{b), c), e)}			2.0 ^{j)} 20 ^{k)}	2.0 ^{j)} 20 ^{k)}	4.0 ^{o), q)}	4.0 ^{o), q)}
11. Fluoride as F [kg/t] ^{b), c)}			3.0 ^{j)} 6.0 ^{m)}	3.0 ^{j)} 6.0 ^{m)}	1.0 ^{o)}	1.0 ^{o)}
12. Total phosphor [kg/t] as P ^{b), c), e)}			0.6 ^{j)} 6.0 ^{k)}	0.6 ^{j)} 6.0 ^{k)}	0.6 ^{o)}	0.6 ^{o)}
13. SO ₄ ²⁻ as S ^{b), c)}			-	n)		
Organic Parameters						
14. CSB as O ₂ [kg/t] ^{b), c), e)}	0.5 ^{g)}	-	0.6 ^{j)} 6.0 ^{k)}	-	2.0 ^{o)}	

Monitoring and sampling requirements:

- a) *Parameters have to be determined by random sampling. Daily frequencies and intervals of sampling have to be set according to the discharge characteristics of the pollutant. Concentrations and loads have to be determined proportional to the flow.*
- b) *Parameters have to be determined by flow-proportional, homogenised and not-settled daily average samples.*
- c) *Emission limits for the parameter 2 and 5-14 of Annexes A-C and parameter 3 of Annex A are met when emission values obtained by four out of five consecutive measurements do not exceed the limit values (rule "4 out of 5") and only one emission value does not exceed the limit value by more than 50 %. For external monitoring (by the competent authority or by an authorised institution) up to 4 times per year, the measurement will have to be repeated, if the emission value exceeds the limit value but does not exceed the limit value by more than 50 %. In that case the emission limit will be met, if the value obtained by the repeated measurement does not exceed the limit value.*
- d) *For the parameters temperature and pH the rule "4 out of 5" applies; the maximum emission value of parameter temperature is 1,2 times the limit value; the maximum/minimum value of the parameter pH must not deviate from the limit by more than $\pm 0,5$ pH.*
- e) *Emission values relate to the total contents of the pollutants.*

Other notes

- f) *No impairment of biological degradation.*
- g) *Emission values refer to the installed product capacity (as tons N of the product).*
- h) *Emission values refer to the production of phosphoric fertilisers and the installed product capacity (as tons P of the product); as to the production of phosphoric acid, the recycling of 90 % of the gypsum must be verified.*
- i) *Emission values refer to the production of phosphoric fertilisers and the installed product capacity (as tons P of the product).*
- k) *Emission values refer to the production of phosphoric acid and the installed product capacity (as tons P of the product).*
- l) *Emission values refer to the production of phosphoric multi-nutrient fertilisers and the installed product capacity (as tons N of the product).*
- m) *In addition to ^k fluorine must be removed (> 80 %) before condensation of the vapours resulting from the concentration of phosphoric acid .*
- n) *Can be determined in case of corrosion .*
- o) *Emission limits refer to the installed product capacity (as tons P of the product).*
- p) *If the content of mercury in the rock phosphate is above 0.1 g/t, the emission value will be 0.06 g/t.*
- q) *In case of NP/NPK-fertilisers with aimed increased addition of trace elements the emission value of 16 g/t has to be met.*

According to the "AEV anorganische Düngemittel", several measures for saving water and waste water treatment have to be taken into consideration in order to reduce the emissions of plants producing inorganic fertilisers, phosphoric acid and its salts, such as

- Watersaving processes, e.g.:
 - Application of multi-stage scrubbers for waste gas treatment;
 - Recirculation of scrubbing liquors and washing waters into the production process;
 - Use of droplet separators in evaporators;
 - Avoidance of the use of co-condensation for the production of MN-fertilisers by the nitro-phosphate route;
 - Multiple use of process waters in other fields of fertiliser production; etc.
- Application of physical-chemical waste water treatment (neutralisation, sedimentation, precipitation/flocculation, filtration); Recovery and/or disposal of residues arising from waste water treatment separate from waste water.

With the application of water-saving processes, the following specific waste water volumes (referred to the finished product) should not be exceeded:

- Inorganic nitrogen fertilisers, incl. ammonium nitrate and urea: 1 m³/t N produced;
- Inorganic phosphoric fertilisers from the decomposition of phosphate rock with sulphuric acid: 10 m³/t P produced;
- NP-acid, NP-fertilisers (nitrophosphate route): 2.5 m³ t/ P produced.

8.1.5 Provisions according to the Seveso II-Directive

Section 8a of the Austrian Industrial Code (Federal Gazette 1994/194 latest amendments by Federal Gazette I 2000/88) contains provisions on the control of major-accident hazards. In section 8a of the Industrial Code obligations of the Seveso II - Directive have been transposed into national law.

As to the Austrian fertiliser production, the following installations are regarded as Seveso II plants:

- Installations for the production of ammonia (Agrolinz Melamin GmbH);
- Installations for the storage of ammonia (Agrolinz Melamin GmbH and Donauchemie GmbH) and
- Installation for the production of urea (Agrolinz Melamin GmbH).

At Agrolinz Melamin GmbH, installations for the production of fertilisers based on ammonium nitrate are not subjected to the legal provisions on the control of major-accident hazards, as the respective thresholds are not exceeded. Ammonium nitrate produced by pressure neutralisation is processed into CAN fertilisers with a nitrogen content below 28 % N ¹⁶.

8.1.6 Product Regulations on Fertilisers in Austria

Product regulations on fertilisers might have an influence on the production of fertilisers, in particular as far as the composition of the product is concerned. Therefore, some aspects of product regulations concerning fertilisers are included in the present study.

In Austria, legal requirements concerning fertilisers are set under the Fertiliser Law (“Düngemittelgesetz”, Federal Gazette 513/1994) and under the Ordinance on Fertilisers (Düngemittelverordnung, Federal Gazette 1007/1994). Fertiliser types, primary nutrient contents, and tolerances are covered by specifications product classification. For example, nitrogen fertilisers based on ammonium nitrate are limited to a maximum nitrogen content of 28 %. Further provisions cover minimum standards for other chemical parameters, such as secondary nutrients, trace elements, liquid fertilisers and some slow-release nitrogen products, as well as packaging and labelling.

The ministerial order on fertilisers among others regulates the total permissible input of heavy metals into agricultural soil (cf. Table 32). Limit values for heavy metal input implies limitations on the heavy metal content of specific fertilisers types, regarding the total permissible input of heavy metals and the recommended annual fertiliser input into agricultural soil.

¹⁶ i.e. the threshold for the nitrogen content in ammonium nitrate according to Annex 5 of the Austrian Industrial Code, (which is identical with the Annex I Part 2 of the Seveso II - Directive)

Table 32: Total permissible input of heavy metal into agricultural soil according to the Austrian ordinance on fertilisers (*Düngemittelverordnung, Federal Law Gazette 1994/1007*).

	Total permissible input until 2005		Total permissible input after 2005	
	Arable land	Grassland and vegetables	Arable land	Grassland and vegetables
Lead	1,250 g/ha ^{a)}	625 g/ha ^{a)}	625 g/ha ^{a)}	315 g/ha ^{a)}
Cadmium	20 g/ha ^{a)}	10 g/ha ^{a)}	10 g/ha ^{a)}	5 g/ha ^{a)}
Chromium	1,250 g/ha ^{a)}	625 g/ha ^{a)}	625 g/ha ^{a)}	315 g/ha ^{a)}
Nickel	750 g/ha ^{a)}	375 g/ha ^{a)}	375 g/ha ^{a)}	190 g/ha ^{a)}
Mercury	20 g/ha ^{a)}	10 g/ha ^{a)}	10 g/ha ^{a)}	5 g/ha ^{a)}

^{a)} g/ha over a period of two years

Additionally, limit values on heavy metal contents are stipulated for mineral fertilisers containing more than 5 % P₂O₅ (cf. Table 33).

Table 33: Limits for heavy metal contents in mineral fertilisers containing more than 5 % P₂O₅ according to the Austrian ordinance on fertilisers (*Düngemittelverordnung, Federal Law Gazette 1007/1994*).

Heavy metal	Cadmium	Chromium ^{a)}	Vanadium
Limit value	75 mg/kg P ₂ O ₅	2,500 mg/kg dry subst.	4,000 mg/kg dry subst.

^{a)} maximum 2 mg Cr (VI)/kg dry substance

An EU Directive (98/97/EC) has been adopted, which allows Austria, Finland, and Sweden to maintain their existing national limits on cadmium in fertilisers until the end of 2001. Recently, this derogation has been extended until the end of 2005 [Commission Decision 2002/366/EC].

8.2 BAT Related Work of International Organisations – The Helsinki Convention

The Helsinki Commission, or HELCOM, is the governing body of the “Convention on the Protection of the Marine Environment of the Baltic Sea Area” – more commonly known as the Helsinki Convention (entered into force on 17 January 2000). The contracting parties to HELCOM are Denmark, Estonia, European Community, Finland, Germany, Latvia, Lithuania, Poland, Russia, Sweden. Decisions on measures to address certain pollution sources or areas of concern are mainly made as HELCOM Recommendations. They are to be implemented by the Contracting Parties through their national legislation.

The Helsinki Commission issued HELCOM Recommendation 17/6 [HELCOM 1996] on reduction of pollution from discharges into water, emissions into the atmosphere and phosphogypsum out of the production of fertilisers. The recommendation contains measures and ELVs for the production fertilisers, which should be implemented by 1 January 1998 for new plants and by 1 January 2002 for existing plants.

8.2.1 Wastewater Discharges

According to the HELCOM Recommendation 17/6 [HELCOM 1996] the amount and harmful effects of wastewater resulting from the production of fertilisers should be kept as low as possible by using the following **measures to avoid/minimise wastewater discharges**, *inter alia*:

- no discharge of phosphogypsum into the recipient;
- use of low pollutant raw materials (e.g. phosphate rock with low heavy metal content wherever possible);
- avoidance of highly contaminated sulphuric acid (residues from industrial processes) for the digestion of phosphate rock;
- re-circulation of waters to the largest extent possible, e.g. of gas scrubbers, application of multistage gas scrubbers;
- re-circulation of vapours, condensates and process waters;
- multiple use of process water in other fields;
- use of rain-waters;
- avoidance of direct cooling/quenching;
- use of dry process methods wherever possible and appropriate.

By the application of these or equivalent techniques and, possibly, in conjunction with the evaporation of small residual waste water quantities, a few products, as for example nitro-lime or superphosphate, could be produced without generation of waste water.

Wastewater which could not be avoided should be treated with the **treatment technologies** given below, if necessary, in combination or by equally effective measures:

- sedimentation/filtration;
- concentration/evaporation, preferably with subsequent re-circulation to production;
- concentration by means of ion exchangers;
- precipitation of phosphate/fluoride/heavy metals by lime slurry, including multistage heavy metal precipitation with flocculation/filtration;
- ammonia stripping;
- biological wastewater treatment with nitrification/denitrification and phosphoric precipitation.

The following **limit values** (as annual average for specific loads) should not be exceeded:

Table 34: Emission limit values for waste water emissions according to [HELCOM 1996].

Pollutant	Production of N containing MN fertilisers (NP, NPK)	Production of straight N-fertilisers	Production of P-fertiliser (P, PK)	Production of Phosphoric Acid
Total N	0.6 kg/t N	0.7 kg/t N	–	–
Phosphate-P	0.04 kg/t N	–	0.05 kg/t P ₂ O ₅	0.02 kg/t P ₂ O ₅
Fluoride	0.15 kg/t N	–	0.3 kg/t P ₂ O ₅	0.05 kg/t P ₂ O ₅
Cadmium	0.02 g/t N	–	0.05 g/t P ₂ O ₅	0.1 g/t P ₂ O ₅
Mercury	0.003 g/t N	–	0.01 g/t P ₂ O ₅	0.01 g/t P ₂ O ₅
Zinc	0.7 g/t N	–	1 g/t P ₂ O ₅	1 g/t P ₂ O ₅

8.2.2 Emissions into the Atmosphere

According to the HELCOM Recommendation 17/6 [HELCOM 1996] air emissions resulting from the production of fertilisers should be treated with appropriate techniques (Table 34) and comply with limit values presented in Table 35:

Table 35: Recommended techniques for air pollution abatement and treatment [HELCOM 17/6].

Operation stage	Emitted substance	Minimisation measure
Reloading and transportation of phosphate rock	Dust	Plant enclosure, waste air treatment by means of filters
Production of single nutrient N-fertiliser	NH ₃	Process optimisation
Production of single nutrient P-fertiliser	HF, phosphate dust	Wet scrubber
Production of NP/NPK fertiliser		
• Dissolution with nitric acid	Fluorides, NO _x	Multi-stage scrubber
• Neutralisation with ammonia	NH ₃ , F compounds	Gas scrubber
• Granulation and drying	Dust	Cyclones
Production of PK fertiliser	Dust, HF, HCl	Wet scrubber
Production of phosphoric acid		
• sulphuric acid dissolution	Fluorides	Wet scrubber
• sulphuric acid/nitric acid dissolution	Fluorides, NO _x	Wet scrubber
• upgrading of acid	Phosphoric acid fog, fluorides	Lamellar precipitator or grid packings

Table 36: Emission limit values for emissions into air according to [HELCOM 1996].

Pollutant	Limit value
NO _x (related to NO ₂) ^{a)}	500 mg/Nm ³
Dust	50 mg/Nm ³ (75 mg/Nm ³ in case of fertilisers containing more than 10% SO ₄ or more than 50% NH ₄ -NO ₃)
Fluorine compounds	5 mg/Nm ³
Chlorine compounds	30 mg/Nm ³

^{a)} only if emissions into the atmosphere of NO_x are expected

8.2.3 Waste (Phosphogypsum)

According to the HELCOM Recommendation 17/6 [HELCOM 1996], phosphogypsum from the sulphuric acid dissolution should be re-used to the extent possible. If this is not practicable, it has to be disposed of in a disposal facility appropriately equipped. A discharge into waters does not comply with BAT.

8.3 List of Abbreviations Used

AC	Ammonium carbonate
AEV	Abwasseremissionsverordnung (Ordinance on the limitation of wastewater emissions)
AN	Ammonium nitrate
AS	Ammonium sulphate
BAT	Best available technique
CAN	Calcium ammonium nitrate
CNTH	Calcium nitrate tetrahydrate
EFMA	European Fertiliser Manufacturing Association
ELV	Emission limit value
FAO	The Food and Agriculture Organisation of the United Nations
HELCOM	Helsinki Commission
IFA	International Fertiliser Industry
IPPC	Integrated Pollution Prevention and Control
K	Potassium
MN	Multi nutrient
N	Nitrogen
P	Phosphorus
ROP	Run-of-pile
SNCR	Selective non-catalytic reduction
SSP	Single Superphosphate
TSP	Triple Superphosphate
UAN	Urea-Ammonium Nitrate
UNEP	United Nations Environment Programme
UNIDO	United Nations Industrial Development Organisation

8.4 Conversion Factors for Nutrients

P_2O_5	x 0.436	=	P (Phosphorus)
K_2O	x 0.830	=	K (Potassium)
CaO	x 0.715	=	Ca (Calcium)
$CaCO_3$	x 0.400	=	Ca (Calcium)
$CaCO_3$	x 0.560	=	CaO (Calcium oxide)
MgO	x 0.603	=	Mg (Magnesium)
$MgCO_3$	x 0.288	=	Mg (Magnesium)
$MgCO_3$	x 0.478	=	MgO (Magnesium oxide)
SO_3	x 0.400	=	S (Sulphur)
SO_4	x 0.333	=	S (Sulphur)
Na_2O	x 0.742	=	Na (Sodium)

9 REFERENCES

- AEV Düngemittel (1996): Ministerial order for the limitation of wastewater emissions from the production of inorganic fertilisers as well as phosphoric acid and its salts, Federal Law Gazette 1996/669.
- AGROLINZ (2001a): Personal communication. Site visit and questionnaire returned on 10.09.2001.
- AGROLINZ (2001b): Geschäftsbericht der Agrolinz Melamin GmbH, 2001; <http://www.agrolinz.com/presse/bericht.html>.
- AGROLINZ (2002a): Übersicht Düngemittel; Agrolinz Melamin GmbH; <http://www.agrolinz.com/produkte/pdfs/duengemittel/duengemittel.pdf>.
- AGROLINZ (2002b). Personal communication. Questionnaire returned on 26.06.2002.
- AGROLINZ (2002c): Personal communication. Questionnaire returned on 17.07.2002.
- AGROLINZ (2002d): Personal communication. Questionnaire returned on 26.07.2002.
- AGROLINZ (2002e): Personal communication. Email received on 25.11.2002.
- Brentall, B.A.; 2000: Phosphate fertilizers, Chapter 5. Economic aspects. Ullmann's Encyclopedia of Industrial Chemistry; Wiley-VCH Verlag GmbH, Weinheim, Germany; revised 2000.
- COM(2001) 508 final: Proposal of 14 September 2001 for a Regulation of the European Parliament and of the Council relating to fertilisers.
- Conradson, A. (2001): Phosphate fertilizers, Chapter 11. Compound Fertilizers by the Nitro Route. Ullmann's Encyclopedia of Industrial Chemistry. Wiley-VCH Verlag GmbH, Weinheim, Germany; revised 2000.
- Denzinger, H.F.J.; König, H.J.; Kruger, G.E.W. (1979): Fluorine recovery in the fertiliser industry – a review. Phosphorous & Potassium; September/October 1979 No. 103, pp. 33-39. <http://www.epa.gov/ttn/chief/ap42/ch08/final/c08s05-1.pdf>.
- Di Lena, S.; Lavanga, M.; Sullivan, S.; Ingram, A. (2000): Recovery of fluosilicic acid and fluoride bearing waters for the production of a mixture of silica and precipitated calcium fluoride usable for the production of cement. IFA technical conference, New Orleans, Louisiana, USA, 1-4 October 2000.
- Donauchemie 2001: Personal communication. Site visit on 10.07.2001 and questionnaire received on 18.07.2001.
- Donauchemie 2002a: Personal communication. Email received on 7.6.2002.
- Donauchemie 2002b: Düngemittel, Produkte; www.donauchemie.at/duenger/produkte.asp Donauchemie, 2002.
- Donauchemie 2002c: Personal communication. Email received on 12.9.2002.
- Donauchemie 2002d: Personal communication. Email received on 31.10.2002.
- EFMA (1995), Best Available Techniques for Pollution Prevention and Control in the European Fertiliser Industry, Booklet N° 8: Production of NPK Fertilizers by the Mixed Acid Route. European Fertilizer Manufacturers Association, Brussels (Belgium), 1995.
- EFMA (1997): Fertiliser industry in the EU. European Fertilizer Manufacturers Association, Brussels (Belgium), June 1997.
- EFMA (2000a), Best Available Techniques for Pollution Prevention and Control in the European Fertiliser Industry, Booklet N° 5: Production of Ammonium Nitrate and Calcium Ammonium Nitrate. European Fertilizer Manufacturers Association, Brussels (Belgium), Revised edition, 2000.
- EFMA (2000b), Best Available Techniques for Pollution Prevention and Control in the European Fertiliser Industry, Booklet N° 6: Production of Urea and Urea Ammonium Nitrate. European Fertilizer Manufacturers Association, Brussels (Belgium), Revised edition, 2000.
- EFMA (2000c), Best Available Techniques for Pollution Prevention and Control in the European Fertiliser Industry, Booklet N° 7: Production of NPK fertilisers by the nitrophosphate route. European Fertilizer Manufacturers Association, Brussels (Belgium), Revised edition, 2000.

- EFMA (2002a): Fertilizer Products. European Fertilizer Manufacturers Association; <http://www.efma.org/introduction/section02.asp>.
- EFMA (2002b): Competitiveness of the EU fertilizer Industry. European Fertilizer Manufacturers Association; <http://www.efma.org/trade/section02.asp>
- EPA (1993a): Compilation of Air Pollutant Emission Factors, AP-42, Fifth Edition, Volume I: Stationary Point and Area Sources, Chapter 8.5: Inorganic Chemical Industry, Phosphate Fertilisers. U.S: Environmental Protection Agency, 1993.
- EPA 1995: Control and Pollution Prevention Options for Ammonia Emissions (EPA-456/R-95-002).
- FAN (2002): Fluoride action network, <http://www.fluoridealert.org>.
- FAOSTAT (2002): Food and Agriculture Organisation of the United Nations; Statistical Databases, <http://apps.fao.org/page/collections>.
- HELCOM (1996): Reduction of pollution from discharges into water, emissions into the atmosphere and phosphogypsum out of the production of fertilisers; HELCOM Recommendation 17/6 adopted 12 .3.1996; Helsinki Commission, Helsinki Convention on the Protection of the Marine Environment of the Baltic Sea Area. www.helcom.fi.
- Hodge, C.A.; Popovici, N.N. (1994): Pollution Control in Fertiliser Production. Marcel Dekker Inc., New York, 1994, 502 cited in [UNEP/UNIDO/IFA 1998] <http://www.epa.gov/ttn/chief/ap42/ch08/final/c08s05-1.pdf>.
- IFA (2002a): International Fertiliser Industry Association; Glossary of Fertiliser Terms; <http://www.fertilizer.org/ifa/publicat/glossary/table.htm>.
- IFA 2002b: International Fertilizer Industry Association, <http://www.fertilizer.org/ifa/statistics.asp>.
- INFOMIL (2001): Dutch notes on BAT for the production of Fertilisers. Information Centre for Environmental Licensing, Ministry of Housing, Spatial Planning and the Environmental Directorate for Climate Change and Industry, December 2001
- Krupp-Uhde 2001: Technology Profile Ammonium nitrate, http://www.krupp-uhde.com/cgi-bin/download.cgi/pdf/TP_an.pdf.
- Laue, W.; Thiemann, W.; Scheibler, E.; Wiegang, K.W. (2001): Nitrates and Nitrites, Chapter 3. Calcium Nitrate. in Ullmann's Encyclopedia of Industrial Chemistry, 2001 Wiley-VCH Verlag GmbH, Weinheim, Germany.
- Lopez-Nino, J.L.; Zurbano, J.A.; Marzo L.M. (1990): Manufacture of Ammonium Nitrate: the Use of a Pipe Reactor and of a Total Air Recycle System for Prilling Tower Pollution Control. IFA technical Conference, Venice, Italy, 1990.
- Meessen, J. H.; Petersen, H (1996): Urea. Ullmann's Encyclopedia of Industrial Chemistry, Vol. A 27, Wiley-VCH Verlag GmbH, Weinheim, Germany, 1996.
- Meyer, T.; Nitzschmann R. (1998): Flexibility of the BASF nitrophosphate process. IFA Technical Conference Marrakech, Morocco. 28 September–1 October 1998.
- Nagy, J. M.; Hilakos, S. W. (1998): PECO Fluorine removal process pilot plant; AICHE Clearwater Convention May 23, 1998.
- OCP 2002: Office Chérifien des Phosphates Morocco; <http://www.ocpgroup.ma>.
- Oosterhuis, F. H.; Brouwer, F.M.; Wijnants, H.J. (2000): A Possible EU Wide Charge on Cadmium in Phosphate Fertilisers: Economic and Environmental Implications. Final Report to the European Commission, Report number E-00/02, April 2000.
- Pawta, M. R.; Shamsi, M. I. (1998): Technology upgradation by breakthrough innovations, GNFC experience with nitrophosphate ODDA process. IFA Technical Conference Marrakech, Morocco. 28 September - 1 October 1998.
- Persson, B. (2000); Phosphate fertilizers, Chapter 8. Superphosphate. Ullmann's Encyclopedia of Industrial Chemistry; Wiley-VCH Verlag GmbH, Weinheim, Germany; revised 2000.
- Sammer, G.; Schindler, I. (2001): BAT for Large Volume Organic Chemicals and Production in Austria. Federal Environment Agency – Austria; Berichte BE-183; Wien, January 2001.

- Scherer, H. W.; Mengel, K., Dittmar, H.; Drach, M.; Vosskamp, R.; Trenkel, M. E.; Gutser, R; Steffens, G.; Czikkely, V.; Niedermaier, T.; Hähndel, R.; Prün H.; Ullrich, K. H.; Mühlfeld, H.; Werner, W.; Günter, K.; Kuhlmann, F.; Steinhauser, H.; Brändlein, W.; Kummer, K. F. (2000): Fertilisers. Ullmann's Encyclopedia of Industrial Chemistry, Wiley-VCH Verlag GmbH, Weinheim, Germany, Revised 2000.
- Smith, P.A. (1999): History of fluorine recovery processes. IFA Technical Sub-committee and committee meeting, Novgorod, Russia, 15-17 September 1999.
- Syers, J. K.; Cisse, L. (2000): Regional differences in the inputs of cadmium to soils. SCOPE Workshop on "Environmental Cadmium in the food chain": Sources, Pathways, and Risks Belgian Academy of Sciences, Brussels, 13-16 September, 2000.
- Syers, K. (2001a): Progress in the development of decadmiation of phosphorous fertilizers. Fertilizer Industry Federation of Australia, Inc., Conference "Fertilizers in Focus", Hyatt Regency, Sanctuary Cove, Hope Island, Queensland, Australia, 28-30 May 2001.
- Syers, K. (2001b): The scope environmental Cadmium Project: Implications for the fertilizer industry. 69th IFA Annual Conference, Sydney, Australia, 21-24 May 2001.
- Thomaschewski, D. (1997): Fertilizer situation in Western Europe. 23rd IFA Enlarged Council meeting, Monte-Carlo, 18-21 November 1997.
- UBA Berlin (2001): German Notes on BAT for the production of Large Volume Solid Inorganic Chemicals, NPK – Fertilizer. Umweltbundesamt, June 2001.
- UNEP/UNIDO/IFA (1998): Fertilizer manual, revised edition, Vienna (Austria)/Muscle Shoals, Alabama (USA), 1998 -United Nations environment programme industry and the environment et. all., Mineral fertilizer production and the environment, the fertilizer industry's manufacturing processes and environmental issues, technical report N° 26 – Part 1, revised edition 1998.
- USGS 2002: Mineral Commodity Summaries. U.S. Geological Survey, January 2002
http://minerals.usgs.gov/minerals/pubs/commodity/phosphate_rock/540302.pdf.
- Wiesenberger H., 2001: State-of-the-art for the production of nitric acid with regard to the IPPC directive, Federal Environment Agency – Austria; Monographien M-150, Wien 2001.
- Wiesenberger, H.; Kircher, J. (2001): Stand der Technik in der Schwefelsäureherstellung im Hinblick auf die IPPC Richtlinie. Federal Environment Agency – Austria; Monographien M-137, Wien 2001.
- Wunder, R. (1990): Abtrennung und Rückgewinnung von anorganischen Stoffen. In: Stofftrennverfahren in der Umwelttechnik, VDI Konferenz 1990, 4-5 Dez.
- Zapp, K.H. (2000): Ammonium Compounds, Chapter 1. Ammoniumnitrate. Ullmann's Encyclopedia of Industrial Chemistry; Wiley-VCH Verlag GmbH, Weinheim, Germany; revised 2000.