

# Improve Steam Turbine Efficiency

## Understand the factors that affect steam consumption

Steam are a major energy consumer. Optimising process operating conditions can considerably improve turbine water rate, which in turn will significantly reduce energy requirement. Various operating parameters affect condensing and back pressure turbine steam consumption and efficiency.

### Why Important

The industrial sector is the largest energy consumer, accounting for about 30 % of total energy used. Fuel and energy prices are continuously rising.

With the present trend of energy prices and scarcity of hydrocarbon resources lowering energy requirement is a top priority. Energy conservation benefits depend on the adopting minor or major modifications and using the latest technology. Energy conservation does not mean curtailing energy use at the cost of industrial and economic growth. In the large process industries, steam turbines are the main energy consumers. Savings achieved here will be significant, with a better return on investment than for most other equipment.

### Effect of operating conditions on steam turbines

A condensing turbine system is shown in figure 1. Turbine exhaust operating below atmosphere, is condensed in a shell and tube exchanger called surface condenser. Condensate flows in the shell side of the condenser and steam is condensed by the cooling water. Vacuum in the surface condenser i.e. turbine exhaust vacuum is controlled/ maintained by vacuum ejector system of the surface condenser.

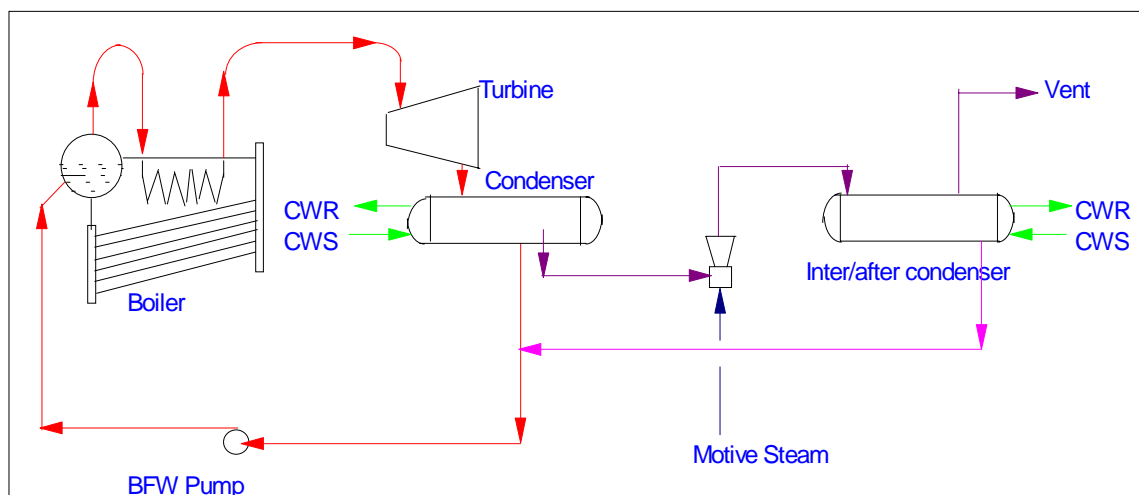

Figure 1 : Diagrammatic details of a condensing type turbine

Turbines are designed for a particular operating conditions like steam inlet pressure, steam inlet temperature and turbine exhaust pressure/ exhaust vacuum, which affects the performance of the turbines in a significant way. Variations in these parameters affects the steam consumption in the turbines and also the turbine efficiency. Theoretical turbine efficiency is calculated as workdone by the turbine to the heat supplied to generate the steam. Efforts are made to show the impact of various operating conditions by considering the following steam conditions as illustration.

<b>Condensing Type turbine</b>		<b>Back pressure type turbine</b>	
<b>Steam inlet pressure</b>	40 kg/cm <sup>2</sup> a	Steam inlet pressure	40 kg/cm <sup>2</sup> a
<b>Steam inlet temperature</b>	350 deg C	Steam inlet temperature	350 deg C
<b>Exhaust vacuum</b>	657 mm Hg	Exhaust pressure	4.5 kg/cm <sup>2</sup> a
<b>Turbine rated BHP</b>	10000 HP	Turbine rated BHP	10000 HP
<b>Steam consumption</b>	27785	Steam consumption	57960

In the above referred turbines, 1 % reduction in steam consumption saves around \$ 47000 annually for condensing turbines and around \$ 84000 annually in back pressure turbine. LHV of the fuel for generating steam is considered as 10500 kcal/kg and boiler efficiency is taken as 87 %. Effect of various operating parameters is illustrated in the succeeding paragraphs.

## 2.1 Effect of Steam inlet pressure

Steam inlet pressure of the turbine also effects the turbine performance. All the turbines are designed for a specified steam inlet pressure. For obtaining the design efficiency, steam inlet pressure shall be maintained at design level. Lowering the steam inlet pressure will hampers the turbine efficiency and steam consumption in the turbine will increase. Similarly at higher steam inlet pressure energy available to run the turbine will be high, which in turn will reduce the steam consumption in the turbine. Figure - 2a & 2b represents the effects of steam inlet pressure on steam consumption and turbine efficiency respectively, keeping all other factors constant for the condensing type turbine.

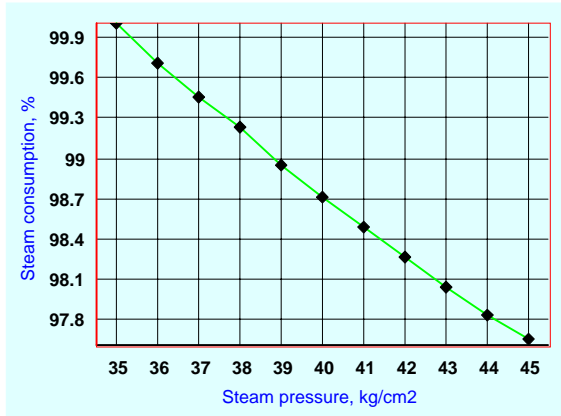

Fig 2a : Effect of steam pressure on steam consumption in condensing type turbine

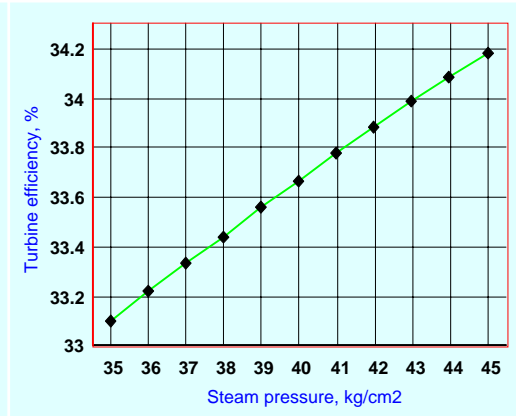

Fig 2b : Effect of steam pressure on turbine efficiency in condensing type turbine

Figure - 2a & 2b indicates that increase in steam inlet pressure by 1 kg/cm<sup>2</sup> in condensing type turbine reduces the steam consumption in the turbine by about 0.3 % and improves the turbine efficiency by about 0.1 % respectively.

In case of back pressure type turbine increase in steam inlet pressure by 1 kg/cm<sup>2</sup> reduces the steam consumption in the turbine by about 0.7 % and improves the turbine efficiency by about 0.16 % as shown in figure - 3a & 3b . Improvement in back pressure type turbine is more than the condensing type turbine.

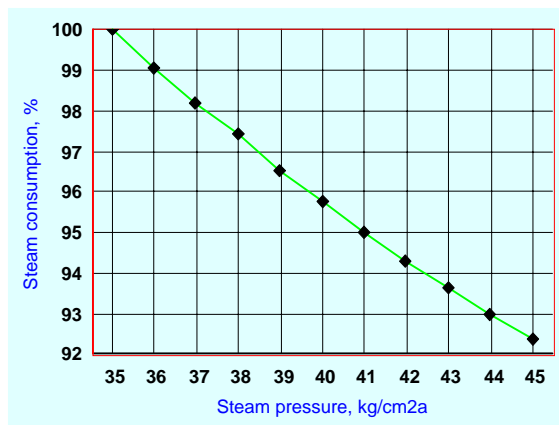

Fig 3a : Effect of steam pressure on steam consumption in back pressure type turbine

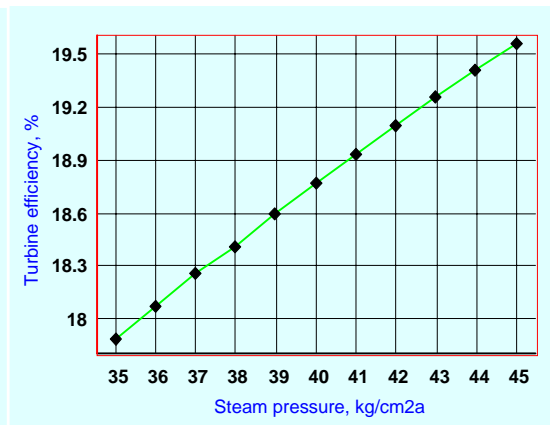

Fig 3b : Effect of steam pressure on turbine efficiency in back pressure type turbine

## 2.2 Effect of Steam inlet temperature

Enthalpy of steam is a function of temperature and pressure. At lower temperature, enthalpy will be low, work done by the turbine will be low, turbine efficiency will be low, hence steam consumption for the required output will be higher. In other words, at higher steam inlet temperature, heat extraction by the turbine will be higher and hence for the required output, steam consumption will reduce. Figure - 4a & 4b represents the effects of steam inlet temperature on steam consumption and turbine efficiency respectively, keeping all other factors constant for the condensing type turbine.

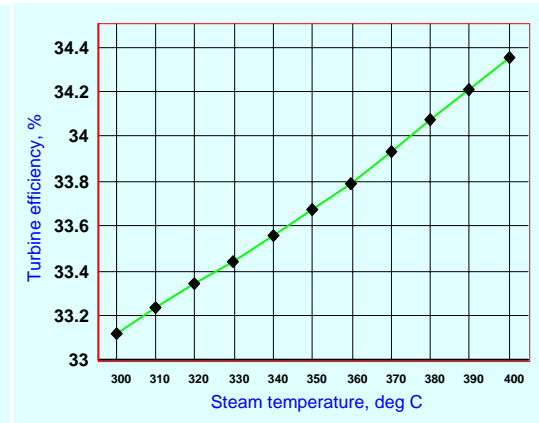
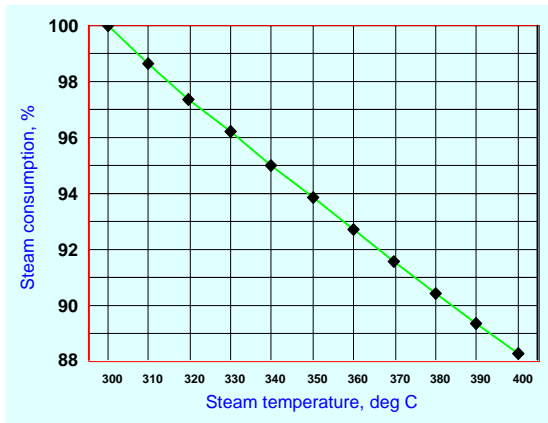

Fig 4a : Effect of steam temperature on steam consumption in condensing type turbine

Fig 4b : Effect of steam temperature on turbine efficiency in condensing type turbine

Figure - 4a & 4b indicates that increase in steam inlet temperature by 10 deg C in condensing type turbine reduces the steam consumption in the turbine by about 1.1 % and improves the turbine efficiency by about 0.12 % respectively.

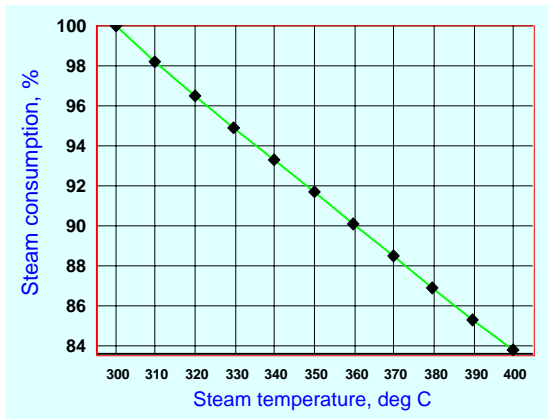

Fig 5a : Effect of steam temperature on steam consumption in back pressure type turbine

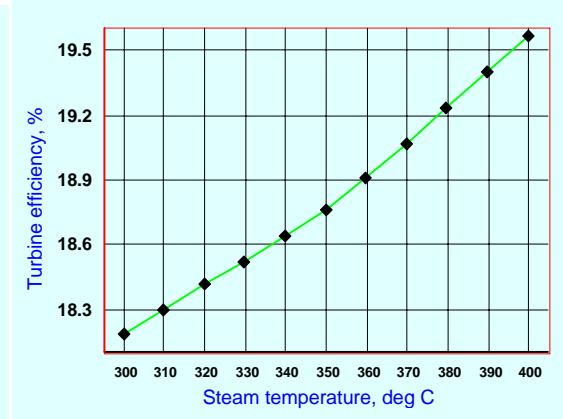

Fig 5b : Effect of steam temperature on turbine efficiency in back pressure type turbine

In case of back pressure type turbine increase in steam inlet temperature by 10 deg C reduces the steam consumption in the turbine by about 1.5 % and improves the turbine efficiency by about 0.12 % as shown in figure - 6a & 6b. Improvement in back pressure type turbine is more than the condensing type turbine.

### 2.3 Effect of exhaust pressure/ vacuum

Higher exhaust pressure/ lower vacuum, increases the steam consumption in the turbine, keeping all other operating parameters constant. Exhaust pressure lower than the specified will reduce the steam consumption and improves the turbine efficiency. Similarly exhaust vacuum lower than the specified, will lower the turbine efficiency and reduces the steam consumption. Figure 6a & 6b represents the effects of exhaust vacuum on steam consumption and turbine efficiency respectively, keeping all other factors constant for the condensing type turbine.

Figure 6a & 6b indicates that improvement in exhaust vacuum by 10 mm Hg, reduces the steam consumption in the turbine by about 1.1 %. Improvement in turbine efficiency varies significantly from 0.24 % to 0.4 %.

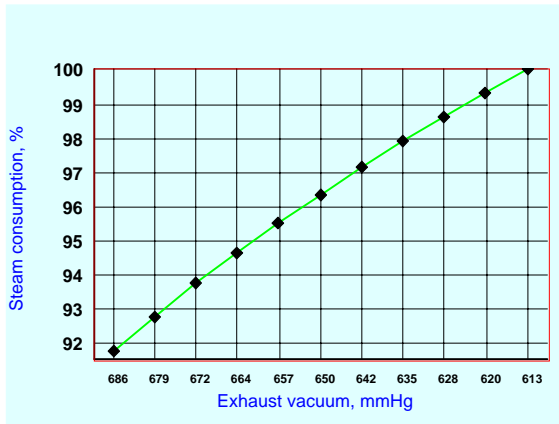

Fig 6a : Effect of exhaust vacuum on steam consumption in condensing type turbine

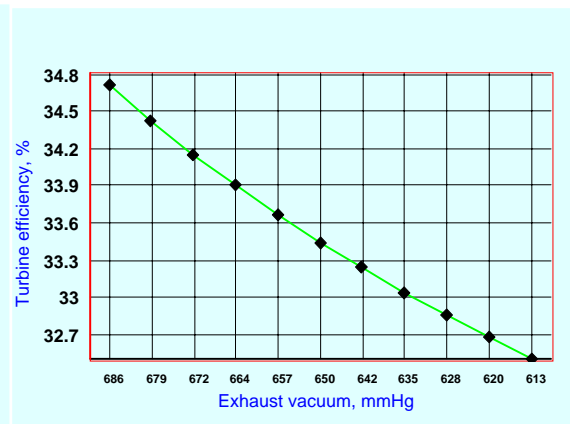

Fig 6b : Effect of exhaust vacuum on turbine efficiency in condensing type turbine

In case of back pressure type turbine reduction in exhaust pressure by 1.0 kg/cm<sup>2</sup>, reduces the steam consumption in the turbine by about 0.8 % and improves the turbine efficiency by about 0.14 % as shown by figure - 7a & 7b.

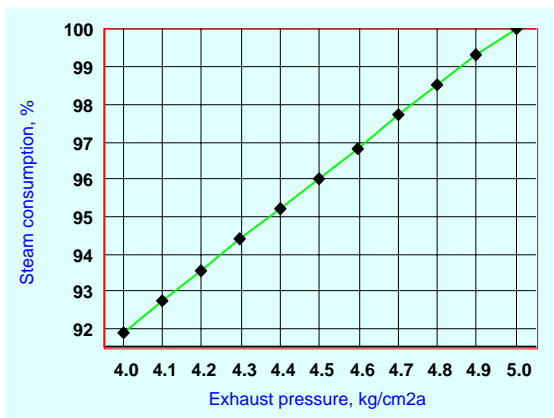

Fig 7a : Effect of exhaust pressure on steam consumption in back pressure type turbine

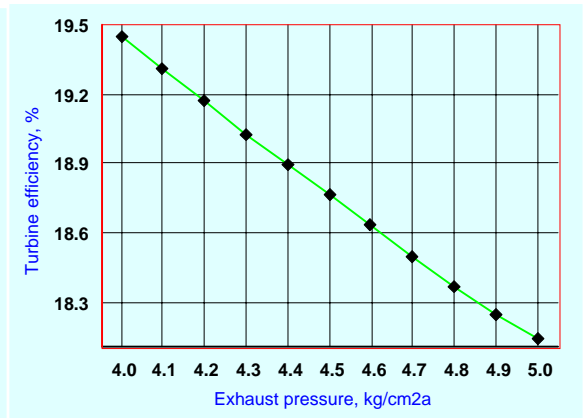

Fig 7b : Effect of exhaust pressure on turbine efficiency in back pressure type turbine

### 2.3.1 Factors affecting the exhaust vacuum in the condensing type turbines

- Vacuum ejector system

Vacuum ejector system creates and maintains the vacuum in the surface condenser by removing the air/ inerts ingress. Removal of air/ inerts ingress is important, as accumulation of this hampers the performance of surface

condenser, which reduces the surface condenser vacuum. Motive steam condition shall be maintained as specified. Inter-after condenser shall be cleaned in the available opportunity, as they get choked due to foreign material coming with cooling water.

- Flange joints shall be tightened properly to avoid any ingress of air.
- Exhaust side of the turbine shall be properly steam sealed to avoid any ingress of air.
- **Higher size of exhaust pipe**

In many condensing turbines it is observed that the exhaust vacuum of these turbines is much less than the vacuum at the condenser. Mainly, it is due to the higher pressure drop in the exhaust pipeline from turbine exhaust to the condenser. In order to improve the vacuum at turbine exhaust so as to reduce steam consumption in the turbine, exhaust pipeline of these turbines can be replaced with higher size. In one of the turbine, exhaust line size of 900 mm was replaced with 1300 mm. The pressure drop in the exhaust pipe reduced by 50 mm Hg i.e. vacuum at the turbine exhaust improved by 50 mm Hg. Pay back period of replacing the exhaust pipeline was 6 months with investment of \$ 40000.

#### **2.4 Replacement of turbine with turbine of improved water rate**

Steam consumption in the older turbines, mainly in the back pressure turbines, is much higher than the new generation turbines. Water rate of older back pressure turbines varies from 35 kg/hr-hp to 50 kg/hr-hp, while water rate of new generation turbines varies from 15 kg/hr-hp to 35 kg/hr-hp.

As a measure to conserve steam so as to conserve the energy cost these turbines can also be replaced. In one of the lube oil single stage turbine steam consumption was 2500 kg/hr, this was replaced with the new single stage turbine with a total cost of \$ 55000. The steam consumption in the new turbine is 1300 kg/hr i.e. steam savings of 1200 kg/hr. Pay back period was just only 5 months.

#### **3.0 Conclusion**

Steam Turbines are one of the main energy consuming equipments, eventhough not much attention is paid to them. Trimming of operating parameters are essential for efficient operation of these turbines. Illustration given in the paper shows impact of operating conditions on steam turbines. Savings presented are for a typical operating conditions. Huge benefits can be reaped by optimizing operating parameters, by minor modifications and even by replacing old in-efficient turbines.

